

# **BIRCHER** Montech GmbH

**Zurrgurten & Hebeteknik**



<b>A</b>		<b>N</b>	
Anschlagketten	1-10	Netze	69
Anschlagseile	16/17/18		
Anschlagpunkt	24 -40	<b>P</b>	
Anschlagwirbel	24-35	Planen	69
Anschweisspunkt	40		
Antirutschmatte	68	<b>R</b>	
Anschlagwirbel Edelstahl	28/29	Ringschraube	37
Anhängernetze	69	Ringmutter	38
Anhängerplanen	69	Rundschlingen	49/50
		Rundschlingengehänge	51/52
		Rundschlingenhacken	56
<b>B</b>		<b>S</b>	
Baggeranschweissshaken	40	Schäckel	19
Blechgreiffer	74	Stirnradflaschenzug	71/72/73
Blechverladehacken	76	Schongreiffer	75
		Schachtringgehänge	78
<b>C</b>		Spezialseile	21
Containernetze	69	Spezialgehänge	53
Containerplanen	69	<b>T</b>	
		Transportring	24
<b>D</b>		Transportöse	24
Drall Fänger	11/12	Trägerklemme	72
Drahtseile	16/17/18	Trägergreiffer	75
Drahtseilzubehör	20	Textilseile	21
		Traverse	13
<b>E</b>		<b>U</b>	
Edelstahlketten	15	Universalkopf	20
Endloshebeband	46		
		<b>W</b>	
<b>H</b>		Windenseile	22
Hebebänder	41-46	Wirbelhaken	2
Hebebandgehänge	47/48		
Hubtisch	80	<b>Z</b>	
		Zurrgurte	57-64
<b>I</b>		Zurrratschen	58/59
Industrieketten	14/15	Zurrhacken	60/61
		Zurrketten	65/66
<b>K</b>		Zurmulde	68
Kettenverkürzer	10		
Kabelziehstrumpf	23		
Kantenschutz	54/55/67		
Kettenzug	71/72/73		
Kranwaage	77		
Kranjoch	13		
Kugelkopfeheber	20		
<b>M</b>			
Magnete	79		

<b>Rabattstufen pro Einkauf:</b>	0 - 150.00 CHF	<b>0%</b>
	150.00 – 400.00 CHF	<b>10 %</b>
	400.00 – 650.00 CHF	<b>12 %</b>
	650.00 -	<b>Auf Anfrage!</b>

**Produkt nicht gefunden?** Zögern Sie nicht anzufragen.

**Sonderanfertigungen:** Sonderanfertigungen und Druck auf Anfrage

**Prüfung von Anschlagmittel:** 1. Jährliche Sachkundigen- Prüfung  
Auf Grundlage der BRG 500 / UVV der Suva  
müssen Kettengehänge mindestens 1 x Jährlich  
durch einen Sachkundigen geprüft werden.  
Diese Prüfung nehmen wir gerne für Sie vor.





Kettengehänge müssen einmal in einem Zeitraum von 3  
Jahren einer zerstörungsfreien Rissprüfung unterzogen  
werden.

Diese Prüfung nehmen wir gerne für Sie vor

**Konditionen:** Exklusiv Mehrwertsteuer  
Preise ab Hellbühl  
Rechnungen sind innert 30 Tagen zu begleichen  
Angaben zu den Preisen ohne Gewähr  
Irrtümer und Druckfehler vorbehalten.

**Kontaktdaten:** **Bircher Montech GmbH**  
Stechenrain  
6016 Hellbühl  
Tel: 079 728 87 33 / 079 852 34 46  
Mail: martin.bircher@bircher-montech.ch  
www.bircher-montech.ch

<b>Anschlagketten</b> ab Seite 1	<b>Anschlagseile</b> ab Seite 16	<b>Drallfänger</b> ab Seite 11	<b>Schäkel</b> ab Seite 19	<b>Schlaufhaken</b> ab Seite 56
				
<b>Antirutschmatte</b> ab Seite 60	<b>Blechgrieffler</b> ab Seite 74	<b>Kantenschutz</b> ab Seite 54/55/67	<b>Kranwaage</b> ab Seite 77	<b>Anschlagpunkte</b> ab Seite 24-40
				
<b>Baggerhaken</b> ab Seite 40	<b>Anschweißpunkt</b> ab Seite 31	<b>Industrieketten</b> ab Seite 14	<b>Magnete</b> ab Seite 79	<b>Windenseile</b> ab Seite 22
				
<b>Kettenratschzug</b> ab Seite 71	<b>Stirnradzug</b> ab Seite 71	<b>Schutzmansch.</b> ab Seite 54	<b>Zurrmulde</b> ab Seite 68	<b>Trägerklemme</b> ab Seite 72
				
<b>Kabelstrumpf</b> ab Seite 23	<b>RS-Gehänge</b> ab Seite 51	<b>Schachtring.</b> ab Seite 78	<b>Netze</b> ab Seite 69	<b>Hubtisch</b> ab Seite 80
				

<b>Zurrgurte</b> ab Seite 57	<b>Hebebänder</b> ab Seite 41	<b>Rundschlingen</b> ab Seite 49	<b>Zurkketten</b> ab Seite 65
			

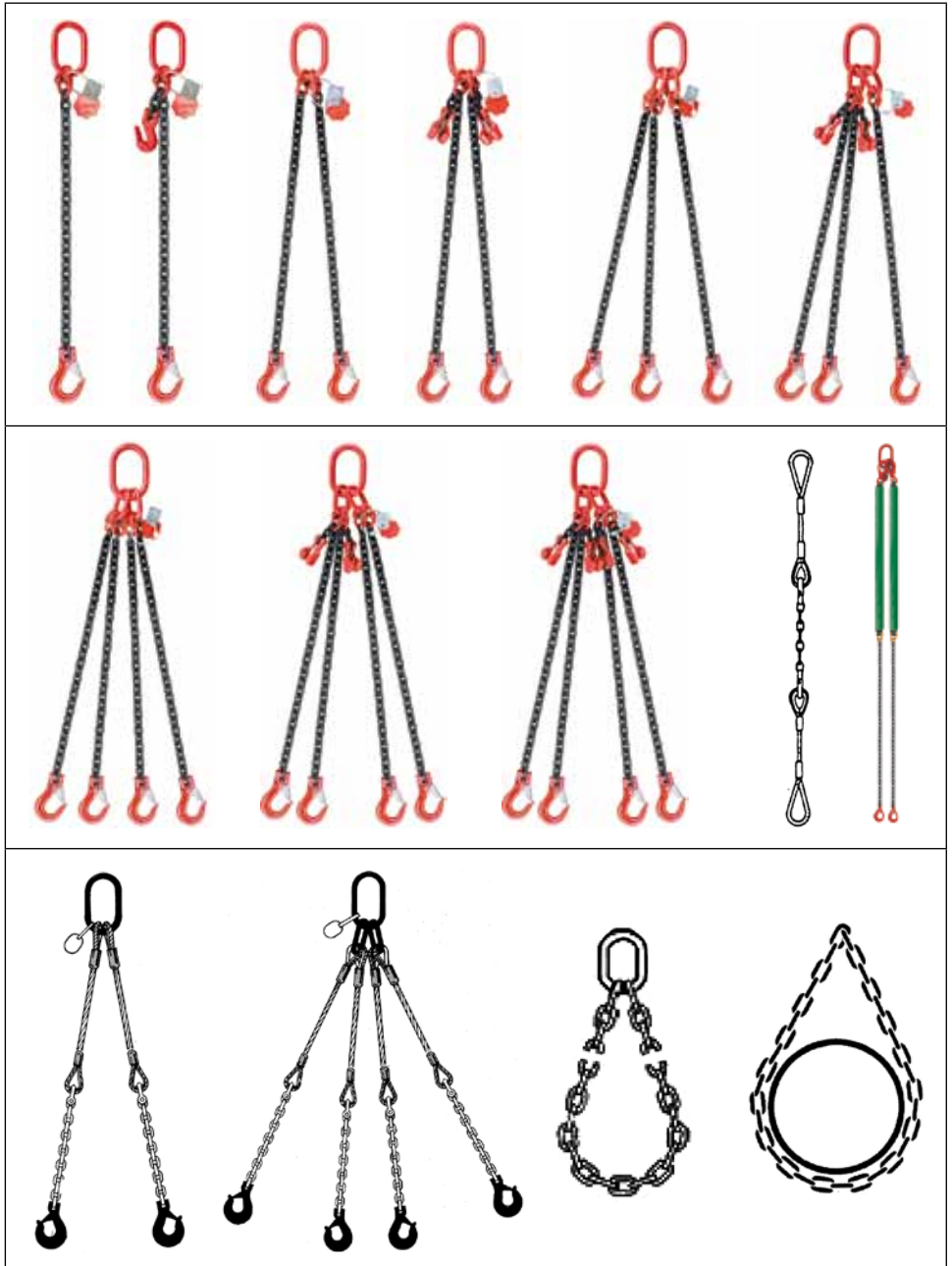

## Wirbelhaken WHS

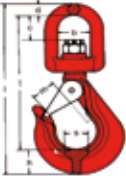
	Nenngröße	WLL in kg	m in mm	s in mm	* Kugellager ball bearing	* mit Scheibe brass bushing
					Preis á/St. CHF	Preis á/St. CHF
	6 - 8	1.120	19	21	142,00	64,00
	7 - 8	1.500	28	25	163,00	85,00
	8 - 8	2.000	28	30	175,00	94,00
	10 - 8	3.150	33	31	202,00	121,00
	13 - 8	5.300	44	42	318,00	210,00

## Wirbelhaken CLW-YE

	Nenngröße	WLL in kg	P in mm	A in mm	* Kugellager ball bearing
					Preis á/St. CHF
	6 - 10	1.400	29	31	160,00
	7/8 - 10	2.500	34	36	170,00
	10 - 10	4.000	44	40	195,00
	13 - 10	6.700	52	46	295,00
	16 - 10	10.000	60	60	490,00
	20 - 10	16.000	90	75	620,00
	22 - 10	19.000	80	97	1.150,00
	26 - 10	26.500	99	123	1.650,00



\* NICHT unter Last drehbar (Scheibe) - Farbe rot

\* UNTER Last drehbar (Kugellager) - Farbe schwarz

## Schafthaken SHS

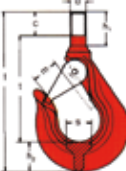
	Nenngröße	WLL in kg	d	m in mm	t in mm	Preis á/St. CHF
	6 - 8	1.120	M 12	20	87	33,00
	7 - 8	1.500	M 14	28	120	43,00
	8 - 8	2.000	M 16	28	124	45,00
	10 - 8	3.150	M 20	33	140	60,00
	13 - 8	5.300	M 24	42	190	112,00

## EN 818-4, Güteklasse 8



Neigungswinkel $\beta$	1 strängig 1 leg		2 strängig 2 legs				3 + 4 strängig 3 and 4 legs	
	0°	0°	0° - 45°	45° - 60°	0° - 45°	45° - 60°	0° - 45°	45° - 60°
Faktor	1	0,8	1,4	1	1,1	0,8	2,1	1,5
	direkt kg	geschnürt kg	direkt kg	direkt kg	geschnürt kg	geschnürt kg	direkt kg	direkt kg
Ketten- nenn- größe mm								
<b>6 - 8</b>	1.120	900	1.600	1.120	1.250	900	2.360	1.700
<b>7 - 8</b>	1.500	1.250	2.120	1.500	1.700	1.250	3.150	2.240
<b>8 - 8</b>	2.000	1.600	2.800	2.000	2.240	1.600	4.250	3.000
<b>10 - 8</b>	3.150	2.500	4.250	3.150	3.550	2.500	6.700	4.750
<b>13 - 8</b>	5.300	4.250	7.500	5.300	6.000	4.250	11.200	8.000
<b>16 - 8</b>	8.000	6.300	11.200	8.000	9.000	6.300	17.000	11.800
<b>18 - 8</b>	10.000	8.000	14.000	10.000	11.200	8.000	21.200	15.000
<b>20 - 8</b>	12.500	10.000	17.000	12.500	14.000	10.000	26.500	19.000
<b>22 - 8</b>	15.000	12.000	21.200	15.000	17.000	12.000	32.000	22.400
<b>26 - 8</b>	21.200	17.000	30.000	21.200	23.600	17.000	45.000	31.500
<b>32 - 8</b>	31.500	25.000	45.000	31.500	35.500	25.000	67.000	47.500
<b>36 - 8</b>	40.000	31.500	56.000	40.000	45.000	31.500	85.000	60.000
<b>40* - 8</b>	50.000	40.000	71.000	50.000	56.000	40.000	106.000	75.000
<b>45* - 8</b>	63.000	50.000	90.000	63.000	71.000	50.000	132.000	95.000
<b>50* - 8</b>	80.000	63.000	112.000	80.000	90.000	63.000	170.000	118.000



\* Diese Kettengehänge sind nur in geschweißter Ausführung lieferbar!



## Preisliste Güteklasse 8

 Ketten DIN EN 818-4 - Grundpreis für den **ersten Meter** in CHF

	SGB	GHS	CLG	+ Verkürzung	Mehrmeter	Strangzahl
Ketten-nenn-größe mm						
<b>6 - 8</b>	75,00	90,00	110,00	20,00	12,00	
<b>7 - 8</b>	80,00	93,00	125,00	21,00	15,00	
<b>8 - 8</b>	85,00	101,00	130,00	22,00	18,00	
<b>10 - 8</b>	100,00	122,00	150,00	29,00	24,00	
<b>13 - 8</b>	148,00	185,00	245,00	42,00	34,00	
<b>16 - 8</b>	235,00	280,00	375,00	70,00	54,00	
<b>6 - 8</b>	125,00	160,00	210,00	40,00	24,00	
<b>7 - 8</b>	130,00	165,00	220,00	42,00	30,00	
<b>8 - 8</b>	135,00	185,00	230,00	44,00	36,00	
<b>10 - 8</b>	175,00	230,00	260,00	58,00	48,00	
<b>13 - 8</b>	250,00	340,00	440,00	84,00	68,00	
<b>16 - 8</b>	425,00	520,00	740,00	140,00	108,00	
<b>6 - 8</b>	180,00	250,00	290,00	60,00	36,00	
<b>7 - 8</b>	190,00	275,00	318,00	63,00	45,00	
<b>8 - 8</b>	210,00	285,00	325,00	66,00	54,00	
<b>10 - 8</b>	280,00	370,00	410,00	87,00	72,00	
<b>13 - 8</b>	400,00	540,00	680,00	126,00	102,00	
<b>16 - 8</b>	690,00	830,00	1100,00	210,00	162,00	
<b>6 - 8</b>	220,00	310,00	370,00	80,00	48,00	
<b>7 - 8</b>	240,00	320,00	380,00	84,00	60,00	
<b>8 - 8</b>	260,00	360,00	400,00	88,00	72,00	
<b>10 - 8</b>	340,00	450,00	510,00	116,00	96,00	
<b>13 - 8</b>	480,00	660,00	820,00	168,00	136,00	
<b>16 - 8</b>	860,00	990,00	1380,00	280,00	216,00	

## Sondergüteklasse 10, grade 100









# XXL

	1 strängig 1 leg		2 strängig 2 legs				3 + 4 strängig 3 and 4 legs	
Neigungswinkel $\beta$	0°	0°	0° - 45°	45° - 60°	0° - 45°	45° - 60°	0° - 45°	45° - 60°
Faktor	1	0,8	1,4	1	1,1	0,8	2,1	1,5
	direkt kg	geschnürt kg	direkt kg	direkt kg	geschnürt kg	geschnürt kg	direkt kg	direkt kg
Ketten-nenn-größe mm								
<b>6 - 10</b>	1.400	1.120	2.000	1.400	1.540	1.120	3.000	2.120
<b>8 - 10</b>	2.500	2.000	3.550	2.500	2.750	2.000	5.300	3.750
<b>10 - 10</b>	4.000	3.200	5.600	4.000	4.400	3.200	8.000	6.000
<b>13 - 10</b>	6.700	5.360	9.500	6.700	7.370	5.360	14.000	10.000
<b>16 - 10</b>	10.000	8.000	14.000	10.000	11.000	8.000	21.200	15.000
<b>19 - 10</b>	14.000	11.200	19.600	14.000	15.400	11.200	29.400	21.000
<b>20 - 10</b>	16.000	12.800	22.400	16.000	17.600	12.800	33.600	24.000
<b>22 - 10</b>	19.000	15.000	26.500	19.000	21.200	15.000	40.000	28.000



## Preisliste Güteklasse 10 (XXL)

Ketten Güteklasse 10 - Grundpreis für den **ersten Meter** in CHF

	GH	CLG	+ Verkürzung	Mehrmeter	Strangzahl
Ketten-nenn-größe mm					<b>XXL</b>
<b>6 - 10</b>	80,00	105,00	25,00	20,00	
<b>8 - 10</b>	97,00	130,00	27,00	27,00	
<b>10 - 10</b>	130,00	163,00	35,00	36,00	
<b>13 - 10</b>	205,00	280,00	62,00	58,00	
<b>16 - 10</b>	285,00	420,00	105,00	88,00	
<b>6 - 10</b>	150,00	210,00	50,00	40,00	
<b>8 - 10</b>	180,00	250,00	54,00	54,00	
<b>10 - 10</b>	245,00	320,00	70,00	72,00	
<b>13 - 10</b>	340,00	480,00	124,00	116,00	
<b>16 - 10</b>	540,00	780,00	210,00	176,00	
<b>6 - 10</b>	230,00	340,00	75,00	60,00	
<b>8 - 10</b>	280,00	390,00	81,00	81,00	
<b>10 - 10</b>	380,00	480,00	105,00	108,00	
<b>13 - 10</b>	570,00	820,00	186,00	174,00	
<b>16 - 10</b>	840,00	1400,00	315,00	264,00	
<b>6 - 10</b>	300,00	440,00	100,00	80,00	
<b>8 - 10</b>	380,00	480,00	108,00	108,00	
<b>10 - 10</b>	480,00	620,00	140,00	144,00	
<b>13 - 10</b>	690,00	990,00	248,00	232,00	
<b>16 - 10</b>	990,00	1520,00	420,00	352,00	

**Sondergüteklasse 12, grade 120**
**GK12**

	1 strängig 1 leg		2 strängig 2 legs				3 + 4 strängig 3 and 4 legs	
	0°	0°	0° - 45°	45° - 60°	0° - 45°	45° - 60°	0° - 45°	45° - 60°
<b>Neigungswinkel B</b>	0°	0°	0° - 45°	45° - 60°	0° - 45°	45° - 60°	0° - 45°	45° - 60°
<b>Faktor</b>	1	0,8	1,4	1	1,1	0,8	2,1	1,5
	direkt kg	geschnürt kg	direkt kg	direkt kg	geschnürt kg	geschnürt kg	direkt kg	direkt kg
<b>Ketten-nenn-größe mm</b>								
<b>8 - 12</b>	3.000	2.360	4.250	3.000	3.350	2.360	6.300	4.500
<b>10 - 12</b>	5.000	4.000	7.100	5.000	5.600	4.000	10.600	7.500
<b>13 - 12</b>	8.000	6.300	11.200	8.000	9.000	6.300	17.000	11.800

**NIRO Kette Edelstahl Güteklasse 5**

Table of Working Load Limit - chain grade 50 Stainless

**G5-NIRO**

	1 strängig 1 leg		2 strängig 2 legs				3 + 4 strängig 3 and 4 legs	
	0°	0°	0° - 45°	45° - 60°	0° - 45°	45° - 60°	0° - 45°	45° - 60°
<b>Neigungswinkel B</b>	0°	0°	0° - 45°	45° - 60°	0° - 45°	45° - 60°	0° - 45°	45° - 60°
<b>Faktor</b>	1	0,8	1,4	1	1,1	0,8	2,1	1,5
	direkt kg	geschnürt kg	direkt kg	direkt kg	geschnürt kg	geschnürt kg	direkt kg	direkt kg
<b>Ketten-nenn-größe mm</b>								
<b>5-Niro</b>	500	400	700	500	560	400	1.050	750
<b>7-Niro</b>	1.000	800	1.400	1.000	1.120	800	2.100	1.500
<b>10-Niro</b>	2.000	1.600	2.800	2.000	2.240	1.600	4.250	3.000
<b>13-Niro</b>	3.250	2.560	4.500	3.200	3.550	2.560	6.700	4.750
<b>16-Niro</b>	5.000	4.000	7.100	5.000	5.600	4.000	10.000	7.500

**Preisliste Güteklasse 12**

Ketten Güteklasse 12 - Grundpreis für den **ersten Meter** in CHF



	KHWP	CLS	+ Ver- kürzung	Mehr- meter	Strangzahl
Ketten- nenn- größe mm					<b>GK12</b>
8 - 12	210,00	295,00	26,00	50,00	
10 - 12	240,00	350,00	34,00	70,00	
13 - 12	290,00	440,00	50,00	105,00	
8 - 12	340,00	480,00	52,00	100,00	
10 - 12	390,00	590,00	68,00	140,00	
13 - 12	520,00	830,00	100,00	210,00	
8 - 12	520,00	740,00	78,00	150,00	
10 - 12	600,00	910,00	102,00	210,00	
13 - 12	890,00	1.310,00	150,00	315,00	
8 - 12	590,00	850,00	104,00	200,00	
10 - 12	740,00	1.070,00	136,00	280,00	
13 - 12	970,00	1.480,00	200,00	420,00	
8 - 12	590,00	850,00	104,00	200,00	
10 - 12	740,00	1.070,00	136,00	280,00	
13 - 12	970,00	1.480,00	200,00	420,00	

**Preisliste Güteklasse 5 NIRO**

 Ketten Güteklasse 5 - Edelstahl - Grundpreis für den **ersten Meter** in CHF

	HSWI	+ Verkürzung	Mehrmeter	Strangzahl
<b>Ketten-nenn-größe mm</b>				<b>GK5 NIRO</b>
<b>5-Niro</b>	290,00	125,00	28,00	
<b>7-Niro</b>	370,00	170,00	44,00	
<b>10-Niro</b>	550,00	225,00	80,00	
<b>13-Niro</b>	670,00	300,00	132,00	
<b>16-Niro</b>	920,00	520,00	195,00	
<b>5-Niro</b>	470,00	250,00	56,00	
<b>7-Niro</b>	630,00	340,00	88,00	
<b>10-Niro</b>	975,00	450,00	160,00	
<b>13-Niro</b>	1220,00	600,00	264,00	
<b>16-Niro</b>	1440,00	1040,00	390,00	
<b>5-Niro</b>	710,00	375,00	84,00	
<b>7-Niro</b>	940,00	510,00	132,00	
<b>10-Niro</b>	1420,00	675,00	240,00	
<b>13-Niro</b>	1490,00	900,00	396,00	
<b>16-Niro</b>	2420,00	1560,00	585,00	
<b>5-Niro</b>	900,00	500,00	112,00	
<b>7-Niro</b>	1190,00	680,00	176,00	
<b>10-Niro</b>	1830,00	900,00	320,00	
<b>13-Niro</b>	2040,00	1200,00	528,00	
<b>16-Niro</b>	3150,00	2080,00	780,00	

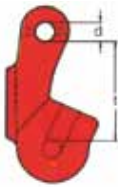
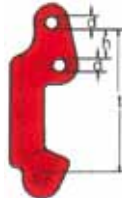
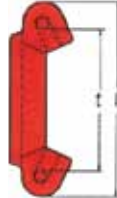
**Verkürzungsklaue**
**VK**

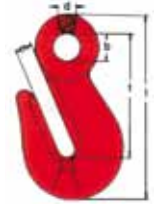
**Einfachverkürzungsklaue**
**EK**

**Doppelverkürzungsklaue**
**DVK**

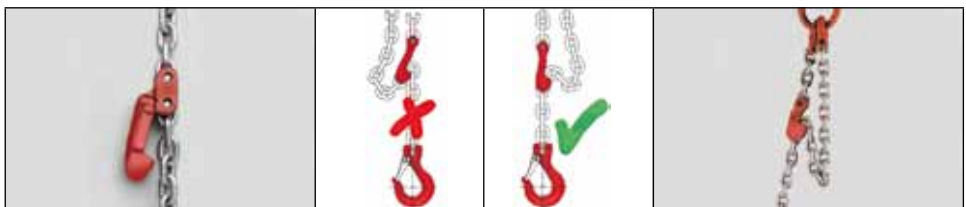
**Verkürzungshaken**
**VHG**

**Verkürzungshaken**
**VHO**

Nenngröße	Preis á/St. CHF	Preis á/St. CHF	Preis á/St. CHF	Preis á/St. CHF	Preis á/St. CHF
6 - 8	45,00*	62,00*	44,00*	20,00	-
6 - 10				25,00	-
7 - 8	52,00*	64,00*	56,00*	21,00	-
8 - 8	55,00*	71,00*	58,00*	22,00	-
8 - 10				27,00	-
10 - 8	63,00*	94,00*	80,00	29,00	-
10 - 10				35,00	-
13 - 8	91,00*	118,00*	111,00	42,00	-
13 - 10				62,00	-
16 - 8	130,00*			70,00	-
16 - 10				105,00	-
18 - 8	314,00				
20 - 8	362,00				
22 - 8	511,00				
26 - 8	1.230,00				



## Drallfänger, isoliert, kugelgelagert, Typ D1

1000 Volt Widerstand  
1000 Volts Resistance

	WLL in kg	für Kette	A in mm	D in mm	L in mm	Preis á/St. CHF
	<b>2.000</b>	8-8	18	9	131	332,00
	<b>3.150</b>	10-8	25	11	162	440,00
	<b>5.300</b>	13-8	30	16	214	525,00
	<b>8.000</b>	16-8	36	19	243	725,00
	<b>12.500</b>	18/20-8	42	22	285	890,00

## Drallfänger, isoliert, kugelgelagert, Typ D10

1000 Volt Widerstand  
1000 Volts Resistance

	WLL in kg	für Kette	D in mm	K in mm	P in mm	W in mm	Preis á/St. CHF
	<b>2.000</b>	8-8	9	136	76	40	338,00
	<b>3.150</b>	10-8	11	170	94	47	445,00
	<b>5.300</b>	13-8	16	219	123	53	532,00
	<b>8.000</b>	16-8	19	256	142	67	745,00
	<b>12.500</b>	18/20-8	22	295	164	80	930,00

## Drallfänger, isoliert, kugelgelagert, Typ D2

1000 Volt Widerstand  
1000 Volts Resistance

	WLL in kg	für Kette	H in mm	L in mm	D in mm	M in mm	T in mm	Preis á/St. CHF
	<b>2.000</b>	8-8	21	118	9	27	18	355,00
	<b>3.150</b>	10-8	29	149	11	34	23	475,00
	<b>5.300</b>	13-8	36	185	16	42	28	585,00
	<b>8.000</b>	16-8	43	217	19	49	33	885,00
	<b>12.500</b>	18/20-8	50	252	22	59	42	995,00



**Drallfänger, isoliert, kuggelagert, Typ D3****1000 Volt Widerstand**  
**1000 Volts Resistance**

	WLL in kg	für Kette	W in mm	L in mm	D in mm	t in mm	A in mm	Preis á/St. CHF
	<b>2.000</b>	8-8	50	118	9	15	18	357,00
	<b>3.150</b>	10-8	65	149	11	19	25	498,00
	<b>5.300</b>	13-8	72	185	16	23	30	585,00
	<b>8.000</b>	16-8	80	217	19	25	36	855,00
	<b>12.500</b>	18/20-8	104	252	22	31	42	1.084,00

**Drallfänger, isoliert, kuggelagert, Typ D5****1000 Volt Widerstand**  
**1000 Volts Resistance**

	WLL in kg	für Kette	H in mm	L in mm	T in mm	W in mm	t in mm	Preis á/St. CHF
	<b>2.000</b>	8-8	23	267	19	50	15	385,00
	<b>3.150</b>	10-8	31	335	23	65	19	505,00
	<b>5.300</b>	13-8	36	410	28	72	23	597,00
	<b>8.000</b>	16-8	45	484	32	80	25	898,00
	<b>12.500</b>	18/20-8	48	558	43	104	31	1.130,00

**Drallfänger, isoliert, kuggelagert, Typ D11****1000 Volt Widerstand**  
**1000 Volts Resistance**

	WLL in kg	für Kette	H in mm	L in mm	T in mm	W in mm	t in mm	Preis á/St. CHF
	<b>2.000</b>	8-8	24	310	20	50	15	400,00
	<b>3.150</b>	10-8	30	374	26	65	19	555,00
	<b>5.300</b>	13-8	39	471	30	72	23	638,00
	<b>8.000</b>	16-8	49	560	36	80	25	920,00
	<b>12.500</b>	18/20-8	62	624	48	104	31	1.394,00

# HTV

Solide Stahlträgerkonstruktion entsprechend der EG Maschinenrichtlinie. Zum Lieferumfang gehören zwei Wirbelhaken.

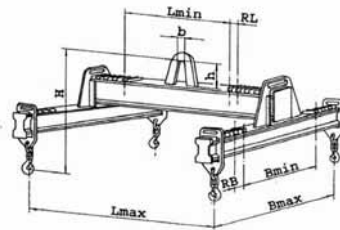

Artikel Nr.	Tragfkt. kg	Länge max. mm	Länge min. mm	Breite max. mm	Breite min. mm	Rastermaß RB	Höhe in mm	Ösenmaß mm	Eigen-gewicht kg	Preis á/St. in CHF
<b>HTV 1-21</b>	1.000	2.000	800	1.000	400	100	525	100x 60	100	auf Anfrage
<b>HTV 3-21</b>	3.000	2.000	800	1.000	400	100	635	120x 80	130	auf Anfrage
<b>HTV 3-31</b>	3.000	3.000	1.000	1.000	400	100	745	120x 80	225	auf Anfrage
<b>HTV 3-32</b>	3.000	3.000	1.000	2.000	800	200	675	120x 80	235	auf Anfrage
<b>HTV 5-32</b>	5.000	3.000	1.000	2.000	800	200	750	120x 80	310	auf Anfrage
<b>HTV 5-42</b>	5.000	4.000	1.000	2.000	800	200	770	120x 80	450	auf Anfrage
<b>HTV 5-52</b>	5.000	5.000	1.500	2.000	800	200	790	120x 80	510	auf Anfrage
<b>HTV 8-52</b>	8.000	5.000	1.500	2.000	800	200	920	150x100	650	auf Anfrage
<b>HTV 8-63</b>	8.000	6.000	2.000	3.000	1.000	200	970	150x100	940	auf Anfrage
<b>HTV 10-42</b>	10.000	4.000	1.000	2.000	800	200	1020	150x100	640	auf Anfrage
<b>HTV 10-63</b>	10.000	6.000	2.000	3.000	1.000	200	1105	150x100	1000	auf Anfrage
<b>HTV 15-63</b>	15.000	6.000	2.000	3.000	1.000	200	1265	330x150	1400	auf Anfrage

**DIN 5685-C**

langgliedrig, verzinkt oder schwarz

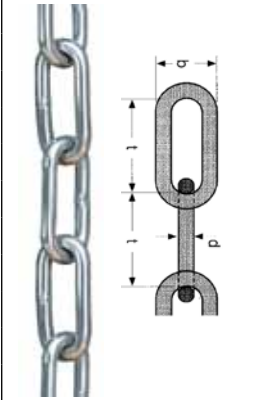
	Stärke mm	innere Länge mm	äußere Breite mm	Bruchlast kg	Preis á/m in CHF
	2	22	6	125	1,90
	2,5	24	10	200	2,00
	3	26	13	280	2,30
	4	32	16	500	2,90
	5	36	20	775	4,00
	6	42	24	1.150	5,00
	7	48	28	1.500	6,60
	8	54	32	2.000	10,50
	10	66	40	3.100	16,20
	12	76	48	4.500	*
	13	82	50	5.300	*

**DIN 5685-A**

kurzgliedrig, verzinkt oder schwarz

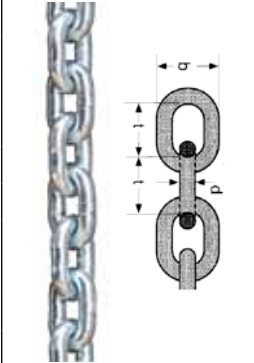
	Stärke mm	innere Länge mm	äußere Breite mm	Bruchlast kg	Preis á/m in CHF
	2	12	7	125	2,00
	2,5	14	9	200	2,10
	3	16	11	280	2,80
	4	19	15	500	3,50
	5	21	19	775	5,20
	6	24	23	1.150	6,40
	7	28	27	1.500	8,40
	8	32	31	2.000	11,20
	10	40	39	3.100	18,00
	13	52	51	5.300	*

\* **Tagespreis** - leider derzeit nur auf Anfrage.

Abgabemengen in Bunden a 30 m. Wir führen diese Ketten in verzinkter Ausführung

**DIN 763 (C)**  
 langgliedrig, Niro

**Niro Edelstahl**

	Stärke mm	innere Länge mm	äußere Breite mm	Bruchlast kg	Preis á/m CHF
	<b>2</b>	22	8	125	4,00
	<b>3</b>	26	12	280	7,90
	<b>4</b>	32	16	630	13,40
	<b>5</b>	35	20	1.000	19,00
	<b>6</b>	42	24	1.250	26,00
	<b>7</b>	49	28	1.900	44,00
	<b>8</b>	52	32	2.500	39,50
	<b>10</b>	65	40	4.000	64,50
	<b>13</b>	82	52	6.300	82,50







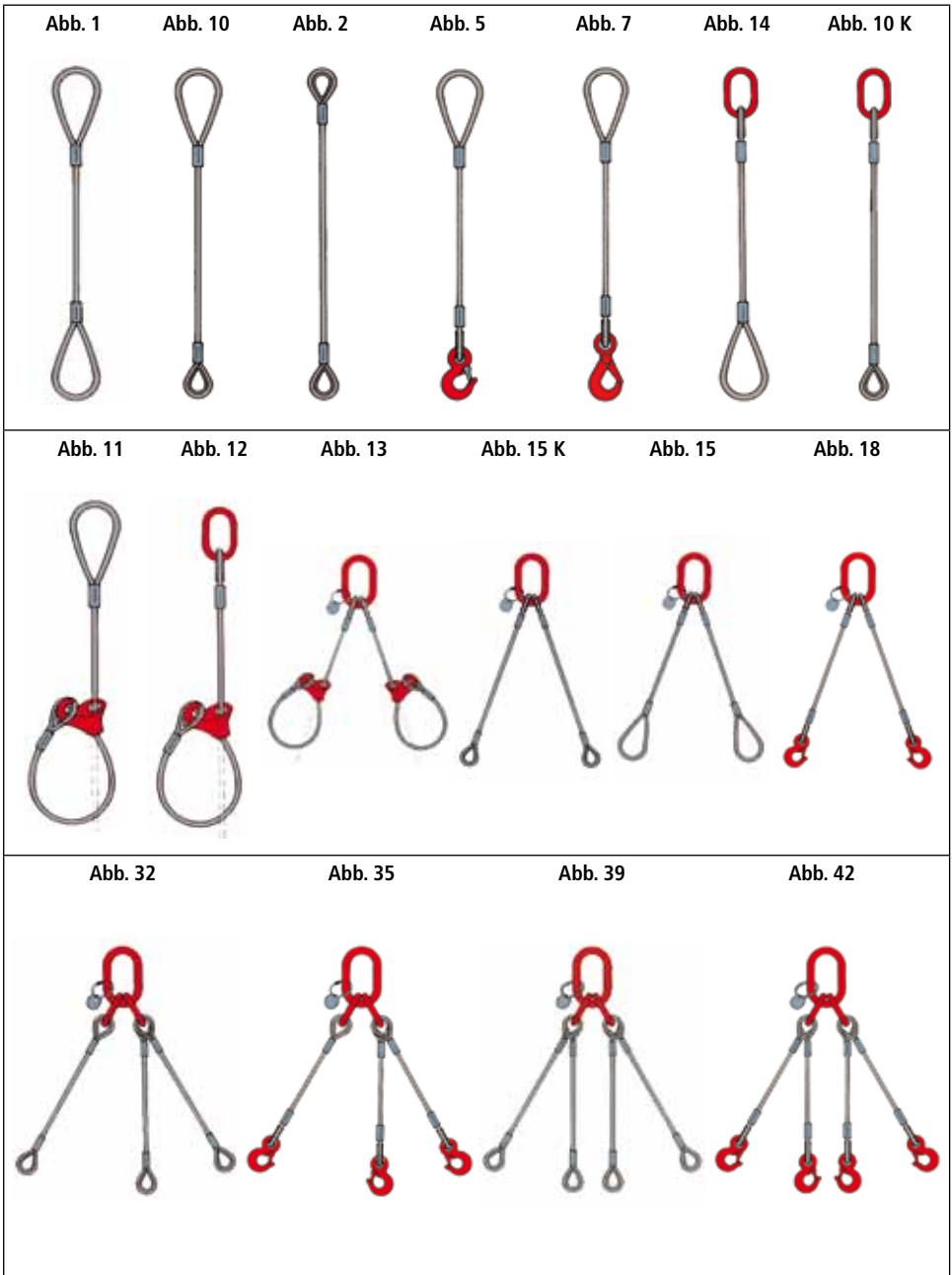

**DIN 766 (A)**  
 kurzgliedrig, Niro

**Niro Edelstahl**

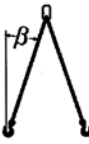
	Stärke mm	innere Länge mm	äußere Breite mm	Bruchlast kg	Preis á/m CHF
	<b>2</b>	12	8	125	8,50
	<b>3</b>	16	11	280	8,50
	<b>4</b>	16	14	800	13,00
	<b>5</b>	18,5	17	1.250	19,00
	<b>6</b>	18,5	20	1.600	28,00
	<b>7</b>	22	23	2.500	64,00
	<b>8</b>	24	26	3.200	50,50
	<b>10</b>	28	34	5.000	79,50
	<b>13</b>	36	44	8.000	152,00







## für Anschlagseile mit Fasereinlage 6 x 19 und 6 x 36, zylindrische Verpressung DIN EN 13414-1 Seilfestigkeitsklasse 1770 N/mm<sup>2</sup>

Seilnenn- durch- messer in mm Faktor	1 strängig 1 leg		2 strängig 2 legs				3 + 4 strängig 3 and 4 legs	
	direkt	geschnürt	0 - 45°		45 - 60°		0 - 45°	45 - 60°
			direkt	geschnürt	direkt	geschnürt	direkt	kg 1,5
	kg 1,0	kg 0,8	kg 1,4	kg 1,1	kg 1,0	kg 0,8	kg 2,1	kg 1,5
Seil- durch- messer in mm								
<b>8</b>	700	560	980	770	700	560	1.400	1.050
<b>10</b>	1.000	800	1.400	1.100	1.000	800	2.100	1.500
<b>12</b>	1.500	1.200	2.100	1.650	1.500	1.200	3.200	2.300
<b>14</b>	2.000	1.600	2.800	2.200	2.000	1.600	4.200	3.000
<b>16</b>	2.700	2.160	3.780	2.970	2.700	2.160	5.700	4.000
<b>18</b>	3.150	2.520	4.410	3.465	3.150	2.520	6.600	4.700
<b>20</b>	4.000	3.200	5.600	4.400	4.000	3.200	8.400	6.000
<b>22</b>	5.000	4.000	7.000	5.500	5.000	4.000	10.500	7.500
<b>24</b>	6.300	5.040	8.820	6.930	6.300	5.040	13.200	9.400
<b>26</b>	7.000	5.600	9.800	7.700	7.000	5.600	14.700	10.500
<b>28</b>	8.000	6.400	11.200	8.800	8.000	6.400	16.800	12.000
<b>32</b>	11.000	8.800	15.400	12.100	11.000	8.800	23.000	16.500
<b>36</b>	14.000	11.200	19.600	15.400	14.000	11.200	29.000	21.000
<b>40</b>	17.000	13.600	23.800	18.700	17.000	13.600	44.700	25.500
<b>44</b>	21.000	16.800	29.400	23.100	21.000	16.800	44.100	31.500
<b>48</b>	25.000	20.000	35.000	27.500	25.000	20.000	52.500	37.500
<b>52</b>	29.000	23.200	40.000	31.900	29.000	23.200	62.000	44.000
<b>56</b>	33.500	26.800	47.000	36.850	33.500	26.800	71.000	50.000
<b>60</b>	39.000	31.200	54.000	42.900	39.000	31.200	81.000	58.000

**Anschlagseile EN 13414-1**

Grundpreise einsatzfertiger Anschlagseile mit 1,0 m Länge

Ø mm	á/St.CHF	Abb. 1	á/St.CHF	Abb. 2	á/St.CHF	Abb. 5	+/- m
8	20,00		21,00		53,00		3,50
10	25,00		27,00		55,00		5,00
12	33,00		35,00		65,00		6,30
14	38,00		40,00		81,00		8,00
16	47,00		53,00		93,00		9,40
18	62,00		67,00		120,00		11,00
20	78,00		82,00		134,00		13,00
22	90,00		95,00		151,00		15,50
24	122,00		126,00		230,00		18,00
26	149,00		161,00		260,00		20,00
28	172,00		192,00		330,00		23,00
30	201,00		222,00		357,00		28,00
32	224,00		283,00		397,00		32,00

Ø mm	á/St.CHF	Abb. 11	+/- m	á/St.CHF	Abb. 18	+/- m
8	62,00		3,50	102,00		7,00
10	63,00		5,00	119,00		10,00
12	72,00		6,30	138,00		12,60
14	88,00		8,00	175,00		16,00
16	99,00		9,40	208,00		18,80
18	170,00		11,00	266,00		22,00
20	201,00		13,00	275,00		26,00
22	211,00		15,50	320,00		31,00
24	245,00		18,00	455,00		36,00
26				540,00		40,00
28						
30						
32						

Ø mm	á/St.CHF	Abb. 19	+/- m
10	244,00		20,00
12	294,00		25,20
14	390,00		32,00
16	465,00		37,60
18	532,00		44,00
20	610,00		52,00
22	732,00		62,00
24	1.010,00		72,00
26	1.190,00		80,00
28	1.480,00		92,00
30	1.710,00		112,00
32	1.910,00	128,00	

**Schäkel hochfest HA 2**



	Tragfähigkeit WLL in t	d1 in mm	d2 in mm	d3 in mm	b2 in mm	h2 in mm	á/St HA2 CHF
	<b>0,50</b>	6,5	8	17	20	28	2,70
	<b>0,75</b>	8	10	21	21	31	2,80
	<b>1,00</b>	10	11	25	26	36	3,00
	<b>1,50</b>	11	13	27	29	42	3,90
	<b>2,00</b>	13	16	30	33	48	5,00
	<b>3,25</b>	16	19	40	43	60	7,50
	<b>4,75</b>	19	22	48	51	71	11,40
	<b>6,50</b>	22	25	54	58	84	16,00
	<b>8,50</b>	25	29	60	68	95	19,80
	<b>9,50</b>	29	32	67	74	108	27,50
	<b>12,00</b>	32	35	76	82	119	39,00
	<b>13,50</b>	35	38	84	92	133	57,00
	<b>17,00</b>	38	41	92	98	146	76,00
	<b>25,00</b>	44	51	110	127	178	148,00
	<b>35,00</b>	51	57	127	146	197	224,00
	<b>55,00</b>	63	70	152	184	267	515,00
	<b>85,00</b>	76	82	165	200	330	
	<b>120,00</b>	89	95	203	230	381	
	<b>150,00</b>	102	108	229	260	432	
	<b>175,00</b>	111	130	262	290	464	

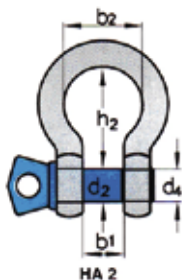



**Universalkopf / Kugelkopfabheber mit Stahlbügel (DEHA)**

	Typ	Tragfähigkeit in to.	Preis á/St. CHF
	<b>BGW-AHK-1.3</b>	1,0 - 1,3	175,00
	<b>BGW-AHK-2.5</b>	1,5 - 2,5	215,00
	<b>BGW-AHK-5.0</b>	3,0 - 5,0	323,00
	<b>BGW-AHK-10.0</b>	6,0 - 10,0	515,00
	<b>BGW-AHK-20.0</b>	12,0 - 20,0	880,00
	<b>BGW-AHK-32.0</b>	32,0	1.900,00

**Rungkupplung mit Stahlbügel**

	Typ	Tragfähigkeit in to.	Preis á/St. CHF
	<b>TPA-2.5</b>	2,5	190,00
	<b>TPA-5.0</b>	5,0	245,00
	<b>TPA-10.0</b>	10,0	440,00
	<b>TPA-26.0</b>	26,0	735,00

**Seilschleufe  
mit Gewindehülse**

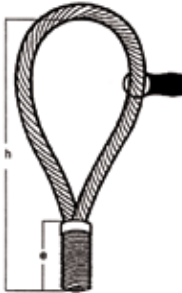
	Gewinde	Tragfähigkeit in kg	Preis á/St. CHF
	<b>M 10</b>	400 kg	10,00
	<b>RD / M 12</b>	500 kg - orange	11,00
	<b>RD / M 14</b>	800 kg - weiß	11,50
	<b>RD / M 16</b>	1200 kg - rot	15,50
	<b>RD / M 18</b>	1600 kg - violett	16,00
	<b>RD / M 20</b>	2000 kg - hellgrün	21,00
	<b>RD / M 24</b>	2500 kg - schwarz	23,00
	<b>RD / M 30</b>	4000 kg - dunkelgr.	27,00
	<b>RD / M 36</b>	6300 kg - blau	45,00
	<b>RD / M 42</b>	8000 kg	64,00
	<b>RD / M 52</b>	12500 kg	99,00

**Ultrahochfeste textile Anschlagseile ähnl. EN 1492-4****NEU**

	Seildurchmesser mm	Tragkraft kg	Preis á/St. 3,0 m CHF	Artikelnummer	Mehr-meter
	8	870	70,00	813-01481	6,30
	10	1.350	90,00	1013-01481	11,00
	12	1.860	102,00	1213-01481	13,50
	14	2.250	120,00	1413-01481	17,20
	16	2.800	142,00	1613-01481	21,20
	18	3.300	155,00	1813-01481	23,70
	20	4.100	181,00	2013-01481	29,00
	22	4.900	228,00	2213-01481	38,20
	24	5.600	300,00	2413-01481	53,20
	26	6.400	326,00	2613-01481	58,30
	28	6.600	390,00	2813-01481	72,00
	30	7.800	440,00	3013-01481	81,40
	32	8.700	468,00	3213-01481	86,60
	34	9.500	525,00	3413-01481	98,60
	36	10.400	595,00	3613-01481	112,30
38	12.100	668,00	3813-01481	124,30	
40	12.900	702,00	4013-01481	132,80	

	Seildurchmesser mm	Tragkraft kg	Preis á/St. 3,0 m CHF	Artikelnummer	Mehr-meter
	8	870	84,00	Abb5-813-01481	6,30
	10	1.350	106,30	Abb5-1013-01481	11,00
	12	1.860	121,80	Abb5-1213-01481	13,50
	14	2.250	146,00	Abb5-1413-01481	17,20
	16	2.800	170,00	Abb5-1613-01481	21,20
	18	3.300	192,00	Abb5-1813-01481	23,70
	20	4.100	221,00	Abb5-2013-01481	29,00
	22	4.900	270,00	Abb5-2213-01481	38,20
	24	5.600	370,00	Abb5-2413-01481	53,20
	26	6.400	396,00	Abb5-2613-01481	58,30
	28	6.600	468,00	Abb5-2813-01481	72,00
	30	7.800	521,00	Abb5-3013-01481	81,40
	32	8.700	576,00	Abb5-3213-01481	86,60
	34	9.500	638,00	Abb5-3413-01481	98,60
	36	10.400	726,00	Abb5-3613-01481	112,30
38	12.100	794,00	Abb5-3813-01481	124,30	
40	12.900	842,00	Abb5-4013-01481	132,80	







## SEWOTA Windenseil ultra hochfest

Ultra hochfestes Windenseil aus Dyneema, Arbeitsdehnung < 1 %, extrem hohe Bruchlast, äüßerst geringes Gewicht, mit eingespleißtem Ösenhaken mit Sicherung, anderes Ende mit Flach-Terminal zur Fixierung an der Windentriommel, zusätzlich zwei aufgezogene verstellbare Schutzschläuche á 1,0 m, UV stabil und scheuerfest

	Artikelnummer	Seildurchmesser in mm	Länge m	Bruchlast Seil daN	Preis komplett in CHF
	<b>01481-0801</b>	8	30	5500	327,00
	<b>01481-0802</b>	8	40	5500	387,00
	<b>01481-1001</b>	10	30	8500	426,00
	<b>01481-1002</b>	10	40	8500	516,00

## SEWOTA Windenseile aus Stahlseil

Auf Grund der Durchmesser Vielfalt bitten wir Sie um Ihre Anfrage. Windenseile konfektionieren wir gerne mit:

	Schleife	Kausche	Haken	Schäkel	Gewinde
					

## SEWOTA Schleppseil

Hochwertiges Schleppseil für extrem hohe Kraftaufnahme im dynamischen Schlepp z.B. Sand, beidseitig mit Auge und Schutzschlauch konfektioniert, bis zu 30 % Dehnung unter Schocklast, sehr leit, 100 % Polyamid, 8-fach quadratgeflochten, weiß

	Artikelnummer	Seildurchmesser in mm	Länge m	Bruchlast Seil daN	Preis komplett in CHF
	<b>01058-2401</b>	24	5	9500	118,00
	<b>01058-2402</b>	24	8	9500	145,00
	<b>01058-2403</b>	24	12	9500	172,00

## Kabelziehstrumpf

aus verzinkter Stahllitze, 1770 N/mm<sup>2</sup>



**eine Seite offen, andere Seite Kausche**

---



**eine Seite offen, andere Seite zwei Kauschen**

---



**beide Seiten offen**

---



weiterhin auf Nachfrage lieferbar:

Kabelnachziehstrümpfe, Kabelfreileitungsstrümpfe,  
Kabelmontagestrümpfe, Kabelhaltestrümpfe

## Transportöse

	Tragfkt.- WLL in kg	Gewinde in mm	Artikelnummer	Preis á/St. CHF
	<b>1.120</b>	M 16 x 30	TWN0123/6	77,00
	<b>2.000</b>	M 20 x 38	TWN0123/8	82,00
	<b>3.150</b>	M 24 x 35	TWN0123/10	88,00

## Transportring

	Tragfkt.- WLL in kg	Gewinde	Artikelnummer	Preis á/St. CHF
	<b>3.150</b>	M16	TWN0122/10	62,00
	<b>5.300</b>	M20	TWN0122/13	122,00
	<b>8.000</b>	M30	TWN0122/16	186,00
	<b>15.000</b>	M36	TWN0122/22	-
	<b>21.200</b>	M42	TWN0122/26	-
	<b>25.000</b>	M45	TWN0122/28	-
	<b>31.500</b>	M56	TWN0122/32	-

## Transportring Titan

	Tragfkt.- WLL in kg	Gewinde in mm	Artikelnummer	Preis á/St. CHF
	<b>1.400</b>	M 16 x 28	F34400	139,00
	<b>2.500</b>	M 20 x 32	F34410	158,00
	<b>4.000</b>	M 24 x 39	F34420	216,00
	<b>6.700</b>	M 30 x 50	F34430	240,00
	<b>8.000</b>	M 36 x 66	F34440	343,00

Titan Transportring mit voller Tragfähigkeit in allen Zugrichtungen!

**Anschlagpunkt FLAT POINT**

	Tragfkt.- WLL in kg	Gewinde in mm	Artikelnummer	Preis á/St. CHF
	500	M 10 x 40	0381100000	99,00
	800	M 12 x 45	0381101000	101,00
	1.500	M 16 x 55	0381101001	102,00
	2.500	M 20 x 70	0381102000	119,00
	4.000	M 24 x 80	0381104000	150,00
	5.000	M 27 x 80	0381105000	220,00
	6.000	M 30 x 90	0381106000	258,00
	8.000	M 36 x 100	0381108000	auf Anfrage

**Anschlagwirbel TSRM**

	Tragfkt.- WLL in kg	Gewinde in mm	Artikelnummer	Preis á/St. CHF
	300	M 8 x 14	TSRM8x14	125,00
	600	M 10 x 1	TSRM10x17	126,00
	1.000	M 12 x 21	TSRM12x21	130,00
	1.300	M 14 x 23	TSRM14x23	151,00
	1.600	M 16 x 27	TSRM16x27	151,00
	2.000	M 18 x 27	TSRM18x27	168,00
	2.500	M 22 x 30	TSRM22x30	168,00
	3.000	M 22 x 33	TSRM22x33	264,00
	4.000	M 24 x 36	TSRM24x36	264,00
	5.000	M 27 x 36	TSRM27x36	308,00
	6.300	M 30 x 45	TSRM30x45	276,00
	10.000	M 36 x 54	TSRM36x54	577,00
	12.500	M 42 x 63	TSRM42x63	638,00
	20.000	M 48 x 68	TSRM48x68	1.050,00
22.000	M 56 x 78	TSRM56x78	1.112,00	

## Anschlagwirbel THEIPA POINT

	Tragfkt.- WLL in kg	Gewinde in mm	Artikelnummer	Preis á/St. CHF
	<b>700</b>	M 12 x 18	THEIPA-0.7	84,00
	<b>1.400</b>	M 16 x 20	THEIPA-1.4	88,00
	<b>2.500</b>	M 20 x 30	THEIPA-2.5	101,00
	<b>4.000</b>	M 24 x 30	THEIPA-4.0	135,00
	<b>6.700</b>	M 30 x 35	THEIPA-6.7	160,00
	<b>8.000</b>	M 30 x 35	THEIPA-8.0	232,00
	<b>10.000</b>	M 36 x 50	THEIPA-10.0	233,00
	<b>12.500</b>	M 42 x 60	THEIPA-12.5	345,00
	<b>17.000</b>	M 45 x 60	THEIPA-17.0	auf Anfrage
	<b>700</b>	M 10 x 18	THEIPA-0.7-M10x18	auf Anfrage
	<b>700</b>	M 12 x 25	THEIPA-0.7-M12x25	auf Anfrage
	<b>700</b>	M 14 x 20	THEIPA-0.7-M14x20	auf Anfrage
	<b>1.400</b>	M 16 x 30	THEIPA-1.4-M16x30	auf Anfrage
	<b>1.400</b>	M 20 x 30	THEIPA-1.4-M20x30	auf Anfrage
	<b>1.400</b>	M 24 x 30	THEIPA-1.4-M24x30	auf Anfrage
	<b>2.500</b>	M 20 x 40	THEIPA-2.5-M20x40	auf Anfrage
	<b>2.500</b>	M 20x 50	THEIPA-2.5-M20x50	auf Anfrage
	<b>2.500</b>	M 20 x 70	THEIPA-2.5-M20x70	auf Anfrage
	<b>4.000</b>	M 24 x 45	THEIPA-4.0-M24x45	auf Anfrage
	<b>4.000</b>	M 24 x 50	THEIPA-4.0-M24x50	auf Anfrage
	<b>4.000</b>	M 30 x 35	THEIPA-4.0-M30x35	auf Anfrage
	<b>6.700</b>	M 30 x 45	THEIPA-6.7-M30x45	auf Anfrage
	<b>6.700</b>	M 30 x 50	THEIPA-6.7-M30x50	auf Anfrage
	<b>6.700</b>	M 30 x 60	THEIPA-6.7-M30x60	auf Anfrage
	<b>8.000</b>	M 30 x 45	THEIPA-8.0-M30x45	auf Anfrage
	<b>10.000</b>	M 36 x 54	THEIPA-10.0-M36x54	auf Anfrage
	<b>12.000</b>	M 42 x 50	THEIPA-12.0-M42x50	auf Anfrage
	<b>12.000</b>	M 42 x 63	THEIPA-12.0-M42x63	auf Anfrage
	<b>12.000</b>	M 45 x 60	THEIPA-12.0-M45x60	auf Anfrage
	<b>12.000</b>	M 48 x 72	THEIPA-12.0-M48x72	auf Anfrage
	<b>17.000</b>	M 42 x 60	THEIPA-17.0-M42x60	auf Anfrage
	<b>17.000</b>	M 48 x 60	THEIPA-17.0-M48x60	auf Anfrage
	<b>17.000</b>	M 56 x 78	THEIPA-17.0-M56x78	auf Anfrage
	<b>20.000</b>	M 64 x 96	THEIPA-20.0-M64x96	auf Anfrage
<b>20.000</b>	M 64 x 110	THEIPA-20.0-M64x110	auf Anfrage	
<b>28.000</b>	M 64 x 96	THEIPA-28.0-M64x96	auf Anfrage	
<b>28.000</b>	M 72 x 120	THEIPA-28.0-M72x120	auf Anfrage	
<b>28.000</b>	M 80 x 150	THEIPA-28.0-M80x150	auf Anfrage	
<b>40.000</b>	M 90 x 115	THEIPA-40.0-M90x115	auf Anfrage	

**Anschlagwirbel THEIPA POINT „F“ mit Innengewinde**

	Tragfkt.- WLL in kg	Gewinde in mm	Artikelnummer	Preis á/St. CHF
	<b>500</b>	M 12 x 15	381800000	188,00
	<b>1.000</b>	M 16 x 20	381801000	192,00
	<b>1.700</b>	M 20 x 25	381802000	214,00
	<b>2.100</b>	M 24 x 30	381804000	301,00
	<b>3.200</b>	M 30 x 40	381806000	340,00
	<b>5.000</b>	M 36 x 45	381808000	385,00

**Anschlagwirbel THEIPA POINT „S“ zum Anschweißen**

	Tragfkt.- WLL in kg	Gewinde in mm	Artikelnummer	Preis á/St. CHF
	<b>2.500</b>	52	381502000	133,00
	<b>4.000</b>	57	381504000	155,00
	<b>6.700</b>	70	381506000	189,00
	<b>10.000</b>	80	381510000	263,00
	<b>17.000</b>	100	381517000	618,00



**NIRO Anschlagwirbel Edelstahl SSDSR / SSDSS**

	Tragfkt.- WLL in kg	Gewinde in mm	Artikelnummer	Preis á/St. CHF
	<b>300</b>	M 8 x 16	SSDSRM8	-
	<b>300</b>	M 8 x 16	SSDSRm8H	-
	<b>500</b>	M 10 x 16	SSDSRM10	-
	<b>500</b>	M 10 x 16	SSDSRM10H	-
	<b>800</b>	M 12 x 19	SSDSRM12	-
	<b>800</b>	M 12 x 19	SSDSRM12H	-
	<b>1.000</b>	M 14 x 29	SSDSRM14H	-
	<b>1.500</b>	M 16 x 26	SSDSRM16H	-
	<b>1.500</b>	M 18 x 30	SSDSRM18H	-
	<b>1.600</b>	M 20 x 30	SSDSRM20H	-
	<b>2.000</b>	M 22 x 42	SSDSRM22H	-
	<b>2.700</b>	M 24 x 42	SSDSRM24H	-
	<b>2.800</b>	M 27 x 42	SSDSRM27H	-
	<b>3.000</b>	M 30 x 47	SSDSRM30H	-
	<b>3.500</b>	M 30 x 45	SSDSSM30	-
	<b>3.500</b>	M 33 x 45	SSDSSM33	-
	<b>5.000</b>	M 36 x 54	SSDSSM36	-
	<b>5.000</b>	M 36 x 54	SSDSSM36x3	-
	<b>5.000</b>	M 39 x 54	SSDSSM39	-
	<b>6.000</b>	M 42 x 63	SSDSSM42	-
<b>6.000</b>	M 42 x 63	SSDSSM42x3	-	
<b>6.000</b>	M 45 x 63	SSDSSM45	-	
<b>6.400</b>	M 48 x 63	SSDSSM48	-	
<b>8.000</b>	M 52 x 63	SSDSSM52	-	

**NIRO Anschlagwirbel Innengewinde SSFEDSR/SSFEDSS**

	Tragfkt.- WLL in kg	Gewinde in mm	Artikelnummer	Preis á/St. CHF
	<b>300</b>	M 8 x 43	SSFEDSRM8x43	-
	<b>500</b>	M 10 x 43	SSFEDSRM10x43	-
	<b>800</b>	M 12 x 43	SSFEDSRM12x43	-
	<b>1.000</b>	M 14 x 43	SSFEDSRM14x43	-
	<b>1.500</b>	M 16 x 43	SSFEDSRM16x43	-
	<b>1.500</b>	M 18 x 47	SSFEDSRM18x47	-
	<b>1.600</b>	M 20 X 47	SSFEDSRM20x47	-
	<b>2.000</b>	M 22 x 47	SSFEDSRM22x47	-
	<b>2.700</b>	M 24 x 66	SSFEDSSM24	-
	<b>2.800</b>	M 27 x 66	SSFEDSSM27	-
	<b>3.500</b>	M 30 x 66	SSFEDSSM30	-
	<b>3.500</b>	M 33 x 66	SSFEDSSM33	-
	<b>5.000</b>	M 36 x 66	SSFEDSSM36	-



**Anschlagwirbel DSR und DSS**

	Tragfkt.- WLL in kg	Gewinde in mm	Artikelnummer	Preis à/St. CHF
	<b>300</b>	M 8 x 14	DSR - M 8	91,00
	<b>600</b>	M 10 x 17	DSR - M 10	92,00
	<b>1.000</b>	M 12 x 21	DSR - M 12	95,00
	<b>1.300</b>	M 14 x 23	DSR - M 14	126,00
	<b>1.600</b>	M 16 x 27	DSR - M 16	126,00
	<b>2.000</b>	M 18 x 27	DSR - M 18	130,00
	<b>2.500</b>	M 20 x 30	DSR - M 20	130,00
	<b>3.000</b>	M 22 x 33	DSR - M 22	205,00
	<b>4.000</b>	M 24 x 36	DSR - M 24	200,00
	<b>5.000</b>	M 27 x 40	DSR - M 27	230,00
	<b>6.300</b>	M 30 x 45	DSR - M 30	213,00
	<b>8.000</b>	M 33 x 50	DSS - M 33	-
	<b>10.000</b>	M 36 x 54	DSS - M 36	-
	<b>12.500</b>	M 42 x 63	DSS - M 42	-
	<b>15.000</b>	M 45 x 63	DSS - M 45	-
	<b>20.000</b>	M 48 x 68	DSS - M 48	-
	<b>20.000</b>	M 52 x 68	DSS - M 52	-
	<b>25.000</b>	M 56 x 78	DSS - M 56	-
	<b>32.100</b>	M 64 x 90	DSS - M 64	-
	<b>33.000</b>	M 64 x 100	Mega DSS - M 64	-
<b>35.000</b>	M 72 x 110	Mega DSS - M 72	-	
<b>40.000</b>	M 80 x 120	Mega DSS - M 80	-	
<b>45.000</b>	M 90 x 135	Mega DSS - M 90	-	
<b>50.000</b>	M 100 x 150	Mega DSS - M 100	-	



**Anschlagwirbel mit Innengewinde FEDSR / FEDSS**

	Tragkt.- WLL in kg	Gewinde in mm	Artikelnummer	Preis á/St. CHF
	<b>300</b>	M 8 x 45	FEDSR M 8 x 45	128,00
	<b>600</b>	M 10 x 45	FEDSR M 10 x 45	130,00
	<b>1.000</b>	M 12 x 45	FEDSR M 12 x 45	130,00
	<b>1.300</b>	M 14 x 45	FEDSR M 14 x 45	132,00
	<b>1.600</b>	M 16 x 45	FEDSR M 16 x 45	132,00
	<b>2.000</b>	M 18 x 62	FEDSR M 18 x 62	203,00
	<b>2.500</b>	M 20 x 62	FEDSR M 20 x 62	203,00
	<b>3.000</b>	M 22 x 62	FEDSR M 22 x 62	239,00
	<b>4.500</b>	M 24 x 66	FEDSS M 24 x 66	-
	<b>5.000</b>	M 27 x 66	FEDSS M 27 x 66	-
	<b>7.300</b>	M 30 x 66	FEDSS M 30 x 66	-
	<b>8.000</b>	M 33 x 66	FEDSS M 33 x 66	-
	<b>10.000</b>	M 36 x 66	FEDSS M 36 x 66	-
	<b>10.000</b>	M 39 x 89	FEDSS M 39 x 89	-
	<b>12.500</b>	M 42 x 89	FEDSS M 42 x 89	-
	<b>15.000</b>	M 45 x 89	FEDSS M 45 x 89	-
<b>20.000</b>	M 48 x 89	FEDSS M 48 x 89	-	
<b>20.000</b>	M 52 x 89	FEDSS M 52 x 89	-	



**Anschlagpunkt/Ringschraube PLAW pewag winner - Profilit Alpha**

	Tragfkt.- WLL in kg	Gewinde in mm	Artikelnummer	Preis à/St. CHF
	<b>300</b>	M 8 x 29	PLAW 0,3	81,00
	<b>630</b>	M 10 x 29	PLAW 0,63	82,00
	<b>1.000</b>	M 12 x 29	PLAW 1,0	84,00
	<b>1.500</b>	M 16 x 29	PLAW 1,5	88,00
	<b>2.500</b>	M 20 x 33	PLAW 2,5	97,00
	<b>4.000</b>	M 24 x 36	PLAW 4,0	118,00
	<b>6.000</b>	M 30 x 49	PLAW 6,0	182,00
	<b>7.000</b>	M 36 x 55	PLAW 7,0	230,00
	<b>8.000</b>	M 36 x 55	PLAW 8,0	306,00
	<b>10.000</b>	M 42 x 65	PLAW 10,0	405,00
	<b>15.000</b>	M 42 x 63	PLAW 15,0	478,00
	<b>20.000</b>	M 48 x 73	PLAW 20,0	555,00



Sondergewindelängen & Zollgewinde jederzeit gerne auf Anfrage lieferbar.

**Anschlagwirbel PLBW pewag winner**

	Tragfkt.- WLL in kg	Gewinde in mm	Artikelnummer	Preis á/St. CHF
	<b>300</b>	M 8 x 13	PLBW 0,3	85,00
	<b>600</b>	M 10 x 15	PLBW 0,6	89,00
	<b>1.000</b>	M 12 x 17	PLBW 1,0	96,00
	<b>1.300</b>	M 14 x 22	PLBW 1,3	112,00
	<b>1.600</b>	M 16 x 24	PLBW 1,6	119,00
	<b>2.000</b>	M 18 x 27	PLBW 2,0	121,00
	<b>2.500</b>	M 20 x 30	PLBW 2,5	132,00
	<b>3.000</b>	M 22 x 33	PLBW 3,0	197,00
	<b>4.000</b>	M 24 x 36	PLBW 4,0	195,00
	<b>5.000</b>	M 27 x 40	PLBW 5,0	197,00
	<b>6.300</b>	M 30 x 45	PLBW 6,3	199,00
	<b>8.000</b>	M 33 x 54	PLBW 8,0	541,00
	<b>10.000</b>	M 36 x 59	PLBW 10,0	552,00
	<b>12.500</b>	M 42 x 69	PLBW 12,5	555,00
	<b>15.000</b>	M 48 x 74	PLBW 15,0	806,00

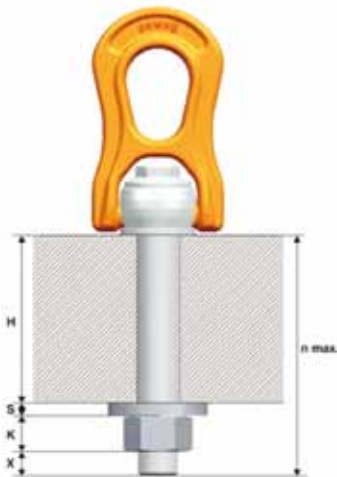

Sondergewindelängen & Zollgewinde jederzeit gerne auf Anfrage lieferbar.

**Anschlagwirbel PLGW pewag winner - Prolift Gamma**

	Tragfkt.- WLL in kg	Gewinde in mm	Artikelnummer	Preis à/St. CHF
	<b>300</b>	M 8 x 15	PLGW 0,3	64,00
	<b>500</b>	M 10 x 15	PLGW 0,5	65,00
	<b>700</b>	M 12 x 20	PLGW 0,7	68,00
	<b>1.500</b>	M 16 x 25	PLGW 1,5	77,00
	<b>2.000</b>	M 20 x 30	PLGW 2,0	88,00
	<b>3.000</b>	M 24 x 35	PLGW 3,0	116,00
	<b>4.000</b>	M 30 x 45	PLGW 4,0	175,00
	<b>7.000</b>	M 36 x 55	PLGW 7,0	238,00
	<b>9.000</b>	M 42 x 65	PLGW 9,0	325,00
	<b>12.000</b>	M 48 x 75	PLGW 12,0	413,00

**Anschlagwirbel PLGW - SN pewag winner - prolift Gamma**

	Tragfkt.- WLL in kg	Gewinde in mm	Artikelnummer	Preis à/St. CHF
	<b>700</b>	M 12 x	PLGW-SN 0,7	62,00
	<b>1500</b>	M 16 x	PLGW-SN 1,5	79,00
	<b>2300</b>	M 20 x	PLGW-SN 2,3	88,00
	<b>3500</b>	M 24 x	PLGW-SN 3,5	110,00

**Anschlagwirbel PLDW pewag winner - Prolift delta**

	Tragfkt.- WLL in kg	Gewinde in mm	Artikelnummer	Preis á/St. CHF
	<b>300</b>	M 8 x 20	PLDW 0,3	81,00
	<b>500</b>	M 10 x 20	PLDW 0,5	81,00
	<b>700</b>	M 12 x 22	PLDW 0,7	83,00
	<b>1.000</b>	M 14 x 22	PLDW 1,0	85,00
	<b>1.500</b>	M 16 x 33	PLDW 1,5	87,00
	<b>2.500</b>	M 20 x 33	PLDW 2,5	101,00
	<b>4.000</b>	M 24 x 40	PLDW 4,0	143,00
	<b>6.000</b>	M 30 x 40	PLDW 6,0	165,00
	<b>8.000</b>	M 36 x 55	PLDW 8,0	249,00
	<b>10.000</b>	M 42 x 60	PLDW 10,0	257,00
	<b>12.500</b>	M 48 x 68	PLDW 12,5	380,00





## Lastbock APLB - Güteklasse 10 - XXL

Artikel	WLL direkt	mm	B	F	H	SW	kg/pce	Preis á/St. CHF
<b>APLB300</b>	300	M 8 x 11	35	85	29	13	0,2	38,00
<b>APLB630</b>	630	M 10 x 16	35	85	29	17	0,3	39,00
<b>APLB1000</b>	1000	M 12 x 18	37	98	36	19	0,5	45,00
<b>APLB1200</b>	1200	M 14 x 21	37	98	36	22	0,5	51,00
<b>APLB1500</b>	1500	M 16 x 24	37	98	36	24	0,5	52,00
<b>APLB2000</b>	2000	M 18 x 26	54	140	44	30	1,3	60,00
<b>APLB2500</b>	2500	M 20 x 30	54	140	44	30	1,3	65,00
<b>APLB4000</b>	4000	M 24 x 36	54	140	44	36	1,4	67,50
<b>APLB4000-M27</b>	4000	M 27 x 38	65	170	62	41	2,8	115,00
<b>APLB5000</b>	5000	M 30 x 48	65	170	62	46	3,1	124,00
<b>APLB7000</b>	7000	M 36 x 54	65	178	65	55	3,3	130,00
<b>APLB8000</b>	8000	M 36 x 62	85	225	78	55	5,8	252,00
<b>APLB10000</b>	10000	M 42 x 72	85	225	78	65	6,3	295,00
<b>APLB15000</b>	15000	M 42 x 57	104	256	86	65	10,8	375,00
<b>APLB20000</b>	20000	M 48 x 72	104	259	90	75	11,6	405,00



**Ringschraube YOKE Sunpoint SPK**

Artikel	WLL (z) nach oben	WLL (x) zur Seite	a	b	c	d	e	F	S	W	Preis á/St. CHF
<b>SPK-M8</b>	1000	300	36	25	8	11	12	25	6	44	29,00
<b>SPK-M10</b>	1000	400	36	25	8	11	15	25	6	44	29,00
<b>SPK-M12</b>	2000	750	42	30	10	13	18	33	8	52	32,00
<b>SPK-M16</b>	4000	1500	51	35	14	13	24	35	10	61	36,00
<b>SPK-M20</b>	6000	2300	57	40	16	17	30	44	12	70	53,00
<b>SPK-M24</b>	8000	3200	70	48	19	21	36	52	14	84	65,00
<b>SPK-M30</b>	12000	4500	86	60	24	26	45	62	17	108	93,00
<b>SPK-M36</b>	16000	7000	103	72	29	32	54	78	22	130	145,00
<b>SPK-M42</b>	24000	9000	120	82	34	38	63	88	24	130	258,00
<b>SPK-M48</b>	32000	12000	137	94	38	43	72	104	27	168	342,00

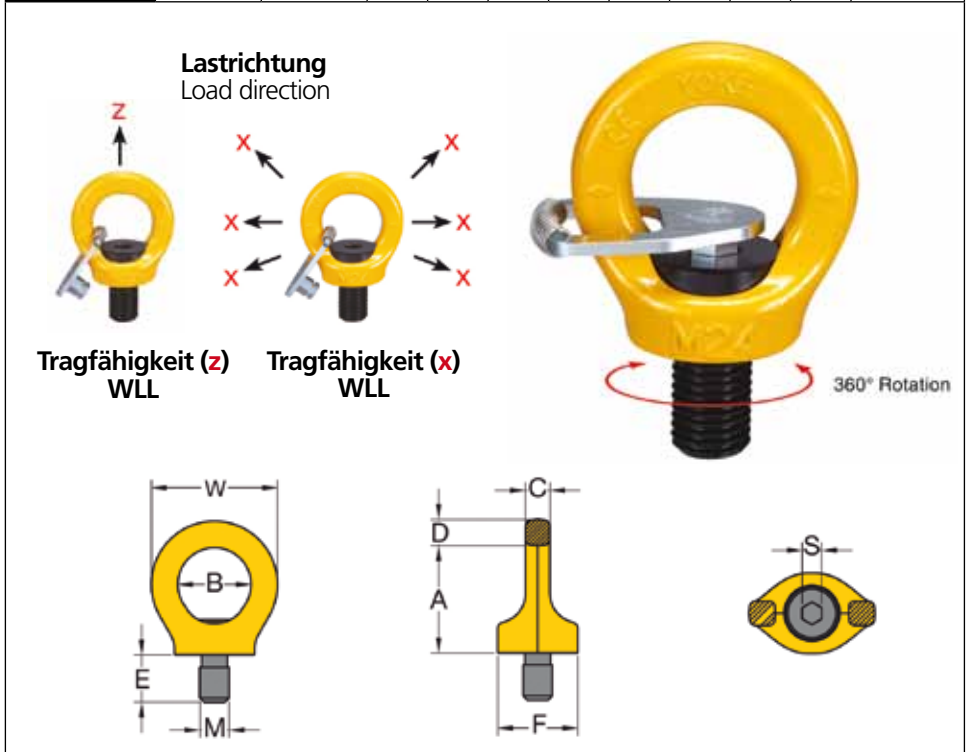

## Ringschraube / Ringmutter C 15 E - verzinkt

	Gewinde	Tragfähigkeit WLL in kg	Ringschraube DIN 580 á/St.CHF	Ringmutter DIN 582 á/St.CHF
	<b>M 6</b>	70	1,40	1,40
	<b>M 8</b>	140	1,60	1,60
	<b>M 10</b>	230	1,90	1,90
	<b>M 12</b>	340	2,70	2,70
	<b>M 14</b>	340	3,70	3,70
	<b>M 16</b>	700	3,70	3,70
	<b>M 18</b>	700	5,60	5,60
	<b>M 20</b>	1.200	5,60	5,60
	<b>M 22</b>	1.200	11,00	11,00
	<b>M 24</b>	1.200	11,00	11,00
	<b>M 27</b>	3.200	20,00	20,00
	<b>M 30</b>	3.200	21,00	21,00
	<b>M 36</b>	4.600	32,00	32,00
	<b>M 42</b>	6.300	52,00	52,00
	<b>M 48</b>	8.600	86,00	86,00
<b>M 56</b>	11.500	120,00	120,00	
<b>M 64</b>	16.000	142,00	142,00	

## Ringschraube / Ringmutter hochfest

Andere Gewindelängen und -stärken auf Anfrage lieferbar!	Gewinde	WLL senkrecht in kg	Ring- schraube á/St.CHF	Ring- mutter á/St.CHF	Ring- schraube- drehbar á/St.CHF
		<b>M 6</b>	400	16,40	15,50
<b>M 8</b>		800	19,00	17,40	31,40
<b>M 10</b>		1.000	21,80	22,00	32,20
<b>M 12</b>		1.600	30,50	26,70	40,00
<b>M 14</b>		3.000	33,00	28,90	-
<b>M 16</b>		4.000	33,00	28,90	46,60
<b>M 18</b>		5.000	48,00	44,20	-
<b>M 20</b>		6.000	48,00	44,20	64,00
<b>M 24</b>		8.000	63,00	55,70	80,80
<b>M 30</b>		12.000	113,00	103,60	116,80
<b>M 36</b>	16.000	201,00	187,80	-	



Die angegebene Tragfähigkeit darf keinesfalls überschritten werden!  
Ringschrauben / Ringmuttern entsprechen der DIN 580/582 - 2003-08

**Anschweisspunkte APA Güteklasse 8 mit Feder**



	WLL in kg	w in mm	h in mm	d in mm	b in mm	Preis á/St. CHF
	<b>1.120</b>	40	38,5	13	38	14,00
	<b>2.000</b>	42	43	14	40	14,00
	<b>3.150</b>	45	48,5	17	45	16,00
	<b>5.300</b>	55	57	22	60	24,00
	<b>8.000</b>	70	67	26	70	37,00
	<b>15.000</b>	97	93,5	34	90	74,00
	<b>37.500</b>	170	175	52	135	-
	<b>50.000</b>	200	215	56	170	-

**Anschweisspunkte APAS Güteklasse 10 mit Feder**



	WLL in kg	w in mm	h in mm	s2 in mm	b in mm	Preis á/St. CHF
	<b>1.400</b>	39,5	41,5	13,5	37	16,00
	<b>2.500</b>	45	47	14	40	17,00
	<b>4.000</b>	50	52	17,5	48	24,50
	<b>6.700</b>	60	61,5	22	60	38,50
	<b>10.000</b>	70	72	26	74	67,40
	<b>16.000</b>	100	102	34	92	119,00
	<b>20.000</b>	110	112	40	104	-



**Baggeranschweisshaken TBA**



	WLL in kg	b in mm	l in mm	m in mm	s in mm	Preis á/St. CHF
	750	57	75	18	14	68,00
	1.250	68	97	23	18	70,00
	2.000	91	80	25	21	79,00
	3.000	105	116	28	24	95,00
	4.000	114	132	33	29	106,00
	5.000	133	162	33	29	128,00
	8.000	136	168	34	40	160,00
	10.000	169	205	49	39	198,00
	12.000	168	220	48	43	420,00

**Anschweißpunkt SPAR - Güteklasse 10 - XXL**

Artikel	WLL direkt	a	b	c	d	e	l	b	kg	Preis á/St. CHF
SPAR-4.000	4000	66	14	30	48	65	135	5	0,7	30,00
SPAR-6.700	6700	85	20	39	60	89	171	5	1,5	58,00
SPAR-10.000	10000	95	21	46	65	100	196	7	2,4	88,00
SPAR-16.000	16000	127	30	57	90	130	263	8	5,5	208,00
SPAR-31.500	31500	187	42	78	130	160	375	15	15,8	571,00

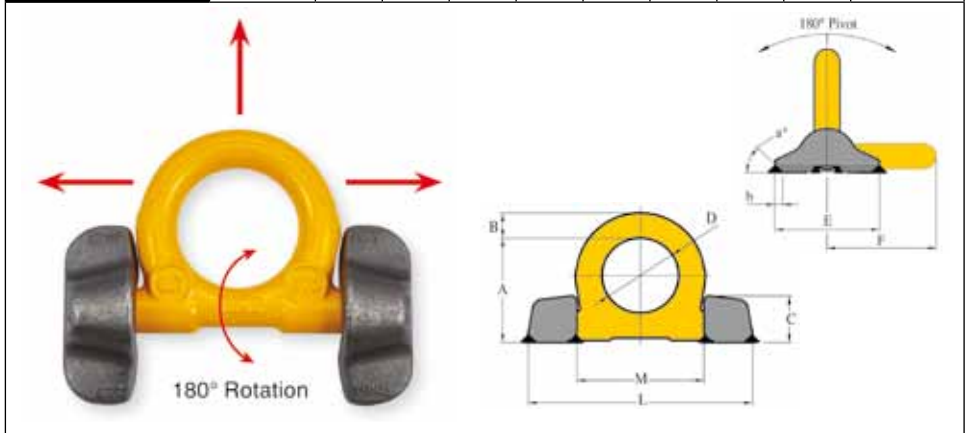

## Tragfähigkeitstabelle

Farben	ein Hebeband One Doublex Flat Sling					zwei Hebebänder Two Doublex Flat Slings			
	direkt kg	geschnürt kg	umgelegt, umschlungen kg			direkt kg	geschnürt kg	direkt kg	geschnürt kg
	0°	0° **	0° *	bis 45°	45°- 60°	bis 45°		45°- 60° **	
<b>violett</b>	1.000	800	2.000	1.400	1.000	1.400	1.120	1.000	800
<b>grün</b>	2.000	1.600	4.000	2.800	2.000	2.800	2.240	2.000	1.600
<b>gelb</b>	3.000	2.400	6.000	4.200	3.000	4.200	3.360	3.000	2.400
<b>grau</b>	4.000	3.200	8.000	5.600	4.000	5.600	4.480	4.000	3.200
<b>rot</b>	5.000	4.000	10.000	7.000	5.000	7.000	5.600	5.000	4.000
<b>braun</b>	6.000	4.800	12.000	8.400	6.000	8.400	6.720	6.000	4.800
<b>blau</b>	8.000	6.400	16.000	11.200	8.000	11.200	8.960	8.000	6.400
<b>orange</b>	10.000	8.000	20.000	14.000	10.000	14.000	11.200	10.000	8.000
<b>diverse</b>	12.000	9.600	24.000	16.800	12.000	16.800	13.440	12.000	9.600
<b>diverse</b>	16.000	12.800	32.000	22.400	16.000	22.400	17.920	16.000	12.800
<b>orange</b>	20.000	16.000	40.000	28.000	20.000	28.000	22.400	20.000	16.000
<b>orange</b>	24.000	19.200	48.000	33.600	24.000	33.600	26.880	24.000	19.200

\* ) Abweichungen durch Handhabungstoleranzen bis 7° zulässig.

\*\* ) Für die Anschlagart „geschnürt“ dürfen nur Schlaufenbänder mit Verstärkung in der Schlaufe verwendet werden.

**Der Öffnungswinkel der Schlaufe maximal 20°!**



# B 2



**DIN EN 1492-1** Typ B2 = 2-lagige Ausführung, beidseitig verjüngte und verstärkte Endschlaufen, imprägniertes Gurtband mit Farbcodierung und Tragfähigkeitskennstreifen, 100 % Polyester, SF 7:1

acc. DIN EN 1492-1, colour code, both side soft eyes with protection, double construction, safety factor 7:1



Artikel Nr.	WLL in kg	Farben	Breite in mm	2,0 m	3,0 m	4,0 m	5,0 m	6,0 m	Mehr- meter á/m CHF
				á/St.CHF	á/St.CHF	á/St.CHF	á/St.CHF	á/St.CHF	
<b>1000 B</b>	1.000	violett	30	18.00	23.00	28.00	33.00	38.00	5.00
<b>2000 B</b>	2.000	grün	60	32.00	40.00	48.00	56.00	64.00	8.00
<b>3000 B</b>	3.000	gelb	90	46.00	60.00	74.00	88.00	102.00	14.00
<b>4000 B</b>	4.000	grau	120	54.00	73.00	92.00	111.00	130.00	19.00
<b>5000 B</b>	5.000	rot	150	86.00	114.00	142.00	170.00	198.00	28.00
<b>6000 B</b>	6.000	braun	180		124.00	154.00	184.00	214.00	30.00
<b>8000 B</b>	8.000	blau	240		166.00	210.00	254.00	298.00	44.00
<b>10000 B</b>	10.000	orange	300		212.00	260.00	308.00	356.00	48.00
<b>12000 B</b>	12.000	orange	300		-	-	-	-	-

# G/S (2-lagig)

**DIN EN 1492-1** Typ G/S = 2-lagige Ausführung, eine Seite Schlaufe, andere Seite DKF- Gurtgehaken, imprägniertes Gurtband mit Farbcodierung und Tragfähigkeitskennstreifen, 100 % Polyester, Sicherheitsetikett, Sicherheitsfaktor 7:1

acc. DIN EN 1492-1, colour code, one side reinforced soft eye, other side sling hook, double construction, safety factor 7:1



WLL in kg	Farben	2,0 m á/St. CHF	3,0 m á/St. CHF	4,0 m á/St. CHF	5,0 m á/St. CHF	6,0 m á/St. CHF	Mehr- meter á/m CHF
1.000	violett	80.00	85.00	90.00	95.00	100.00	5.00
2.000	grün	112.00	120.00	128.00	136.00	144.00	8.00
3.000	gelb	132.00	146.00	160.00	174.00	188.00	14.00
5.000	rot	-	412.00	440.00	468.00	496.00	28.00
6.000	braun	-	-	-	-	-	-
8.000	blau	-	-	-	-	-	-
10.000	orange	-	-	-	-	-	-

Hebebänder mit größeren Tragfähigkeiten finden Sie auf den folgenden Seiten oder auf Anfrage.

Other capacities and special lengths available upon request.



# V (2-lagig)

**DIN EN 1492-1** Typ V = 2-lagige Ausführung, eine Seite Schlaufe, andere Seite SIKA- Vario- Gurtehaken mit Schnepfer, Sicherheitsfaktor 7:1

acc. DIN EN 1492-1, colour code, one side soft eye, other side SIKA sling hook with keeper, double construction, safety factor 7:1

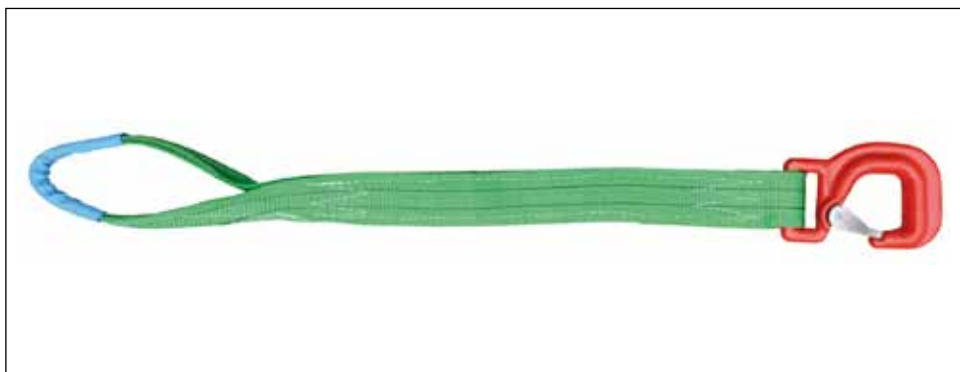

Artikel 2000 V							
WLL in kg	Farben	2,0 m	3,0 m	4,0 m	5,0 m	6,0 m	Mehr- meter á/m CHF
		á/St. CHF	á/St. CHF	á/St. CHF	á/St. CHF	á/St. CHF	
2.000	grün	112.00	120.00	128.00	136.00	144.00	8.00

FN - Gurtehaken  
Nenngröße 1, 2, 3 und 5 to.)

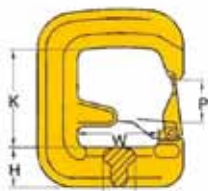

SIKA-Vario Gurtehaken  
(nur Nenngröße 8-8 / 2.000 kg)



**POWER-Hebebänder, 4-lagige Ausführung**

Tragfkt. in kg	Breite in mm	4 m á/St. CHF	5 m á/St. CHF	6 m á/St. CHF	8 m á/St. CHF	10 m á/St. CHF	12 m á/St. CHF	14 m á/St. CHF
2.000	30	98.00	113.00	128.00	158.00	188.00	218.00	248.00
4.000	60	150.00	170.00	180.00	220.00	260.00	300.00	340.00
6.000	90	200.00	225.00	250.00	300.0	350.00	400.00	452.00
8.000	120	-	-	-	-	-	-	-
10.000	150	-	-	-	-	-	-	-
12.000	180	-	-	-	-	-	-	-
16.000	240							
20.000	300							
24.000	300							



4.000	60	240.00	260.00	280.00	320.00	360.00	400.00	440.00
6.000	90	420.00	445.00	470.00	520.00	570.00	620.00	670.00
8.000	120	590.00	620.00	650.00	710.00	770.00	830.00	890.00
10.000	150							
12.000	180							
16.000	240							
20.000	300							

auf Anfrage



4.000	60	290.00	310.00	330.00	370.00	410.00	450.00	490.00
6.000	90	480.00	505.00	530.00	580.00	630.00	680.00	730.00
8.000	120	640.00	670.00	700.00	760.00	820.00	880.00	940.00
10.000	150							
12.000	180							
16.000	240							
20.000	300							

auf Anfrage



# A 2 (1-lagig)

**DIN EN 1492-1** Typ A2 = 1-lagige Ausführung, endlos vernäht, imprägniertes Gurtband mit Farbcodierung und Tragfähigkeitskennstreifen, 100 % Polyester, Sicherheitsetikett, SF 7:1

acc. DIN EN 1492-1, colour code, endless type, single construction, safety factor 7:1

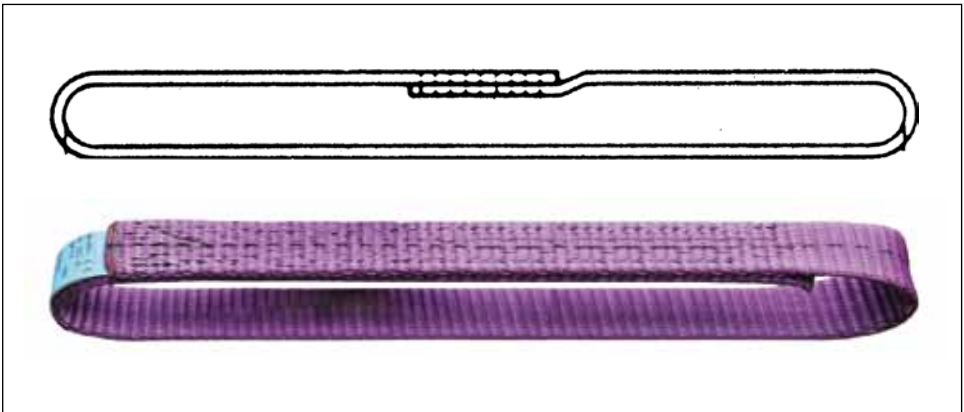

WLL in kg	Farben	Breite in mm	EWL 1,0 m	EWL 2,0 m	EWL 3,0 m	EWL 4,0 m	EWL 5,0 m	EWL 6,0 m	EWL 8,0 m
			Umfang 2,0 m	Umfang 4,0 m	Umfang 6,0 m	Umfang 8,0 m	Umfang 10,0 m	Umfang 12,0 m	Umfang 16,0 m
			á/St. CHF	á/St. CHF	á/St. CHF	á/St. CHF	á/St. CHF	á/St. CHF	á/St. CHF
<b>1.000</b>	violett	30	9.00	14.00	19.00	24.00	29.00	34.00	44.00
<b>2.000</b>	grün	60	14.00	21.00	28.00	35.00	42.00	49.00	63.00
<b>3.000</b>	gelb	90	20.00	31.00	42.00	53.00	64.00	75.00	97.00
<b>4.000</b>	grau	120	26.00	40.00	54.00	68.00	82.00	96.00	124.00
<b>5.000</b>	rot	150	34.00	54.00	74.00	94.00	114.00	134.00	154.00
<b>6.000</b>	braun	180	65.00	90.00	115.00	140.00	165.00	190.00	240.00

## Hebebandgehänge Tragfähigkeitstabelle



	1 strängig 1 leg		2 strängig 2 legs				3 + 4 strängig 3 and 4 legs	
	Neigungswinkel $\beta$		0 - 45°		45 - 60°		0 - 45°	45 - 60°
Belastungsfaktor	1,0	0,8	1,4	1,1	1,0	0,8	2,1	1,5
	direkt kg	geschnürt kg	direkt kg	geschnürt kg	direkt kg	geschnürt kg	direkt kg	
Farbe								
<b>violett</b>	1.000	800	1.400	1.100	1.000	800	2.100	1.500
<b>grün</b>	2.000	1.600	2.800	2.200	2.000	1.600	4.200	3.000
<b>gelb</b>	3.000	2.400	4.200	3.300	3.000	2.400	6.300	4.500
<b>grau</b>	4.000	3.200	5.600	4.400	4.000	3.200	8.400	6.000
<b>rot</b>	5.000	4.000	7.000	5.500	5.000	4.000	10.500	7.500
<b>braun</b>	6.000	4.800	8.400	6.600	6.000	4.800	12.600	9.000
<b>blau</b>	8.000	6.400	11.200	8.800	8.000	6.400	16.800	12.000
<b>orange</b>	10.000	8.000	14.000	11.000	10.000	8.000	21.000	15.000
<b>orange</b>	15.000	12.000	21.000	16.500	15.000	12.000	31.500	22.500

## Hebebandgehänge Preisliste

	Tragfkt.- WLL in kg	L1 1,0 m á/St.CHF	L1 1,5 m á/St.CHF	L1 2,0 m á/St.CHF	L1 2,5 m á/St.CHF	L1 3,0 m á/St.CHF	Mehr- meter á/m CHF
	1.000	95.00	97.50	100.00	102.50	105.00	5.00
	2.000	102.00	106.00	110.00	114.00	118.00	8.00
	3.000	116.00	123.00	130.00	137.00	144.00	14.00
	5.000	-	-	180.00	194.00	208.00	28.00
	8.000					300.00	44.00

	1.400	190.00	195.00	200.00	205.00	210.00	10.00
	2.800	214.00	222.00	230.00	238.00	246.00	16.00
	4.200	227.00	241.00	255.00	269.00	283.00	28.00
	7.000			320.00	348.00	376.00	56.00
	11.200			-	-	-	

	Tragfkt.- WLL in kg	L1 1,0 m á/St.CHF	L1 1,5 m á/St.CHF	L1 2,0 m á/St.CHF	L1 2,5 m á/St.CHF	L1 3,0 m á/St.CHF	Mehr- meter á/m CHF
	2.100	283.00	290.50	298.00	305.50	313.00	15.00
	4.200	316.00	328.00	340.00	352.00	364.00	24.00
	6.300	353.00	374.00	395.00	416.00	437.00	42.00
	10.500			540.00	582.00	624.00	84.00
	16.800			-	-	-	

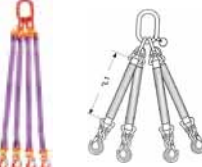
	2.100	372.00	382.00	392.00	402.00	412.00	20.00
	4.200	418.00	434.00	450.00	466.00	482.00	32.00
	6.300		470.00	498.00	526.00	554.00	56.00
	10.500			660.00	716.00	772.00	112.00
	16.800						

Die oben angegebenen Preise beziehen sich auf Hebebandgehänge in montierter Ausführung mit Verbindungsgliedern und SIKA-SOB-Ösenhaken. Die Hebebänder können jederzeit bei Verschleiß ausgetauscht werden. Gerne bieten wir Ihnen diese Gehänge auch mit anderen Hakentypen an.

Weitere Längen und Tragfähigkeiten auf Anfrage.

Other capacities and special lengths available upon request.

**Tragfähigkeitstabelle**

Farben	eine Rundschlinge One Round Sling					zwei Rundschlingen Two Round Slings			
	direkt kg	geschnürt kg	umgelegt, umschlungen kg			direkt kg	geschnürt kg	direkt kg	geschnürt kg
	0°	0°	0° *	bis 45°	45°- 60°	bis 45°		45°- 60°	
<b>violett</b>	1.000	800	2.000	1.400	1.000	1.400	1.120	1.000	800
<b>grün</b>	2.000	1.600	4.000	2.800	2.000	2.800	2.240	2.000	1.600
<b>gelb</b>	3.000	2.400	6.000	4.200	3.000	4.200	3.360	3.000	2.400
<b>grau</b>	4.000	3.200	8.000	5.600	4.000	5.600	4.480	4.000	3.200
<b>rot</b>	5.000	4.000	10.000	7.000	5.000	7.000	5.600	5.000	4.000
<b>braun</b>	6.000	4.800	12.000	8.400	6.000	8.400	6.720	6.000	4.800
<b>blau</b>	8.000	6.400	16.000	11.200	8.000	11.200	8.960	8.000	6.400
<b>orange</b>	10.000	8.000	20.000	14.000	10.000	14.000	11.200	10.000	8.000
<b>orange</b>	12.000	9.600	24.000	16.800	12.000	16.800	13.440	12.000	9.600
<b>orange</b>	15.000	12.000	30.000	21.000	15.000	21.000	16.800	15.000	12.000
<b>orange</b>	20.000	16.000	40.000	28.000	20.000	28.000	22.400	20.000	16.000
<b>orange</b>	30.000	24.000	60.000	42.000	30.000	42.000	33.600	30.000	24.000
<b>orange</b>	40.000	32.000	80.000	56.000	40.000	56.000	44.800	40.000	32.000
<b>orange</b>	50.000	40.000	100.000	70.000	50.000	70.000	56.000	50.000	40.000

\* ) Abweichungen durch Handhabungstoleranzen bis 7° zulässig.

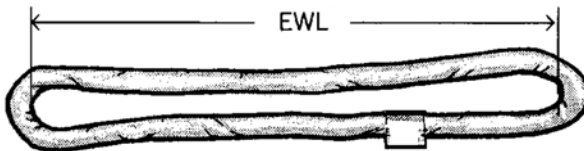

**Mit GS-Zeichen für Tragfähigkeiten bis 30.000 kg!**

# RSK (Köperschlauch)

**DIN EN 1492-2** Typ RSK = Köperschlauch, verbesserte Doppelmantelqualität, PU-impregnierter Polyesterschlauch mit Farbcodierung und Tragfähigkeitskennstreifen, 100 % PES, Sicherheitsetikett, SF 7:1



Artikel Nr.	Trag-fkt.	Farben	EWL 1,0 m	EWL 1,5 m	EWL 2,0 m	EWL 2,5 m	EWL 3,0 m	EWL 4,0 m	EWL 5,0 m	EWL + m
article No.	load in to.	colour	Umfang perimeter 2,0 m	Umfang perimeter 3,0 m	Umfang perimeter 4,0 m	Umfang perimeter 5,0 m	Umfang perimeter 6,0 m	Umfang perimeter 8,0 m	Umfang perimeter 10,0 m	Mehr-meter
			á/St. CHF	á/St. CHF	á/St. CHF	á/St. CHF	á/St. CHF	á/St. CHF	á/St. CHF	á/m CHF
<b>RSK 1.000</b>	1	violett	12.00	15.00	18.00	21.00	24.00	30.00	36.00	6.00
<b>RSK 2.000</b>	2	grün	16.00	20.50	25.00	29.50	34.00	43.00	52.00	9.00
<b>RSK 3.000</b>	3	gelb	17.00	23.50	30.00	36.50	43.00	56.00	69.00	13.00
<b>RSK 4.000</b>	4	grau	22.00	31.00	40.00	49.00	58.00	76.00	94.00	18.00
<b>RSK 5.000</b>	5	rot	22.00	32.00	42.00	52.00	62.00	82.00	102.00	20.00
<b>RSK 6.000</b>	6	braun	28.00	39.00	50.00	61.00	72.00	94.00	116.00	22.00
<b>RSK 8.000</b>	8	blau			68.00	84.00	100.00	132.00	164.00	32.00
<b>RSK 10.000</b>	10	orange			82.00	102.00	122.00	162.00	202.00	40.00
<b>RSK 12.000</b>	12	orange								
<b>RSK 15.000</b>	15	orange								
<b>RSK 20.000</b>	20	orange								
<b>RSK 30.000</b>	30	orange								
<b>RSK 40.000</b>	40	orange								
<b>RSK 50.000</b>	50	orange								

Bitte senden Sie uns für Rundschlingen über 10.000 kg Ihre Anfrage.

Other capacities and special lengths available upon request.

## Rundschlingengehänge Tragfähigkeitstabelle





	1 strängig 1 leg		2 strängig 2 legs				3 + 4 strängig 3 and 4 legs	
			0 - 45°		45 - 60°		0 - 45°	45 - 60°
Neigungs- winkel $\beta$								
Belastungs- faktor	1,0	0,8	1,4	1,1	1,0	0,8	2,1	1,5
	direkt kg	geschnürt kg	direkt kg	geschnürt kg	direkt kg	geschnürt kg	direkt kg	
Farbe								
<b>violett</b>	1.000	800	1.400	1.100	1.000	800	2.100	1.500
<b>grün</b>	2.000	1.600	2.800	2.200	2.000	1.600	4.200	3.000
<b>gelb</b>	3.000	2.400	4.200	3.300	3.000	2.400	6.300	4.500
<b>grau</b>	4.000	3.200	5.600	4.400	4.000	3.200	8.400	6.000
<b>rot</b>	5.000	4.000	7.000	5.500	5.000	4.000	10.500	7.500
<b>braun</b>	6.000	4.800	8.400	6.600	6.000	4.800	12.600	9.000
<b>blau</b>	8.000	6.400	11.200	8.800	8.000	6.400	16.800	12.000
<b>orange</b>	10.000	8.000	14.000	11.000	10.000	8.000	21.000	15.000
<b>orange</b>	15.000	12.000	21.000	16.500	15.000	12.000	31.500	22.500



**Rundschlingengehänge Preisliste**

	Tragfkt.- WLL in kg	L1 1,0 m á/St.CHF	L1 1,5 m á/St.CHF	L1 2,0 m á/St.CHF	L1 2,5 m á/St.CHF	L1 3,0 m á/St.CHF	Mehr- meter á/m CHF
	<b>1.000</b>	93.00	96.50	100.00	103.50	107.00	7.00
	<b>2.000</b>	100.00	105.00	110.00	115.00	120.00	10.00
	<b>3.000</b>	116.00	123.00	130.00	137.00	144.00	14.00
	<b>5.000</b>	-	-	180.00	190.00	200.00	20.00
	<b>8.000</b>					280.00	30.00

	<b>1.400</b>	186.00	193.00	200.00	207.00	214.00	14.00
	<b>2.800</b>	210.00	220.00	230.00	240.00	250.00	20.00
	<b>4.200</b>	227.00	241.00	255.00	269.00	283.00	28.00
	<b>7.000</b>			320.00	340.00	360.00	40.00
	<b>11.200</b>			-	-	-	



	Tragfkt.- WLL in kg	L1 1,0 m á/St.CHF	L1 1,5 m á/St.CHF	L1 2,0 m á/St.CHF	L1 3,0 m á/St.CHF	L1 4,0 m á/St.CHF	Mehr- meter á/m CHF
	<b>2.100</b>	277.00	287.50	298.00	308.50	319.00	21.00
	<b>4.200</b>	310.00	325.00	340.00	355.00	370.00	30.00
	<b>6.300</b>	353.00	374.00	395.00	416.00	437.00	42.00
	<b>10.500</b>			540.00	570.00	600.00	60.00
	<b>16.800</b>			-	-	-	

	<b>2.100</b>	364.00	378.00	392.00	406.00	420.00	28.00
	<b>4.200</b>	410.00	430.00	450.00	470.00	490.00	40.00
	<b>6.300</b>		470.00	498.00	526.00	554.00	56.00
	<b>10.500</b>			660.00	700.00	740.00	80.00
	<b>16.800</b>			-	-	-	

Weitere Längen und Tragfähigkeiten auf Anfrage.



**Ersatzrundschnitten jederzeit lieferbar**



**Sonderanschlagmittel**

<b>Kombigehänge Rundschlinge-Kette</b>	<b>Umkehrgehänge</b>
	

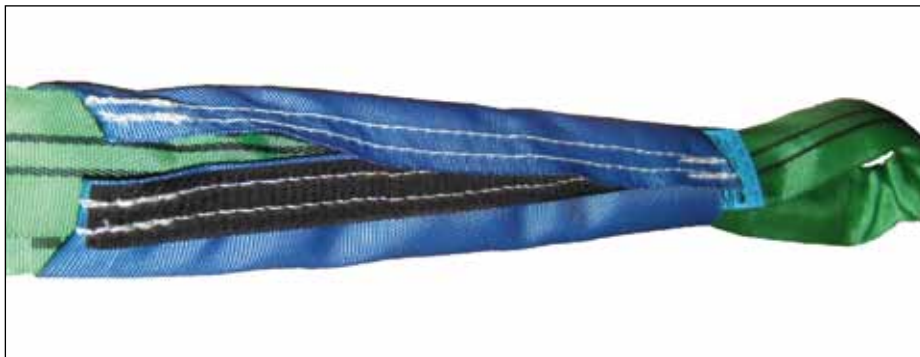

Wir produzieren und konfektionieren Sonderanschlagmittel mit unterschiedlichen Komponenten aus dem Anschlagmittelbereich. Fragen Sie uns einfach an.

**Typ XL aus Polyester Deckband mit Klettverschluss**

Artikel	Breite	Rundschnlle	Rundschnlle	für 2-lagige	Preis
		einzel Strang	beide Stränge	Hebebänder	
					
SM-120-DB-á/m	120			1000 kg / 30 mm	17,50
SM-140-DB-á/m	140	1			18,50
SM-160-DB-á/m	160	2	1 + 2		18,50
SM-180-DB-á/m	180	3 + 4		2000 kg / 60 mm	20,50
SM-200-DB-á/m	200	5	3 + 4		21,50
SM-250-DB-á/m	250	6 + 8	5 + 6	3000 kg / 90 mm	25,50
SM-300-DB-á/m	300	10 + 15 + 20	8 + 10		30,00



## Typ XXL Power aus Polyester Hebegurtband mit Klettverschluss

Artikel	Breite	Rundschlinge	Rundschlinge	für 2-lagige	Preis
		einzel Strang	beide Stränge	Hehebänder	
					
SM-180-HGB-á/m	180	3 + 4		2000 kg / 60 mm	24,00
SM-240-HGB-á/m	240	5 + 6	3 + 4	3000 kg / 90 mm	29,00
SM-300-HGB-á/m	300	8, 10, 15, 20	8 + 10		31,00
SM-360-HGB-á/m	360	30		5000 kg / 150 mm	37,00
SM-480-HGB-á/m	480	40	15	6000 kg / 180 mm	42,00
SM-560-HGB-á/m	560	50	20, 30		48,00
SM-780-HGB-á/m	780		40 + 50	1000 kg / 3000 mm	55,00
SM-1200-HGB-á/m	1200		100		89,00



**Rundschlingenhaken RSH**











	Artikel	WLL in kg	m in mm	b in mm	t in mm	Preis á/St. CHF
	<b>RSH6-8</b>	1000	31	41	123	31,50
	<b>RSH8-8</b>	2000	40	55	148	44,00
	<b>RSH10-8</b>	3000	50	55	175	75,00
	<b>RSH-4000</b>	4000	59	70	223	175,00
	<b>RSH13-8</b>	5000	59	70	223	135,00
	<b>RSH-6000</b>	6000	59	70	223	210,00
	<b>RSH16-8</b>	8000	80	100	317	413,00
	<b>RSH18-8</b>	10000	80	100	317	480,00













## Zurrgurte DIN EN 12195-2 - VDI 2700ff



**Zurratschen und Klemmschlösser**





















25 mm	25 mm	35 mm
Klemmschloß Bruchlast 450 daN 	Hobbyratsche H Bruchlast 800 kg 	Klemmschloß Bruchlast 700 kg 
Klemmschloß Bruchlast 500 daN 	Zurratsche Z Bruchlast 1500 kg 	Zurratsche Standard Bruchlast 2000 kg 
Klemmschloß schweißb. Bruchlast 680 daN 	Zurratsche Z Bruchlast 1500 kg 	Zurratsche groß Bruchlast 3000 kg 
Spannbügel flach Bruchlast 200 kg 		Zurratsche SEWOTA mit Wirbelhaken 

**Zurratschen und Klemmschlösser**

50 mm	50 mm	50 mm
<p>Zurratsche SEWOTA Standard</p> 	<p>Zurratsche SEWOTA Ergo Langhebel</p> 	<p>Zurratsche SEWOTA mit Gurtbandhalter</p> 
<p>Zurratsche SEWOTA Power</p> 	<p>Zurratsche SEWOTA mit Wirbelhaken</p> 	
<p>Zurratsche SEWOTA kurz, schmaler Griff</p> 	<p>Klemmschloß 50 mm 900 daN, schweißbar</p> 	
<p>Zurratsche SEWOTA kurz, breiter Griff</p> 	<p>Zurratsche SEWOTA NIRO Edelstahl</p> 	<p>Zurratsche SEWOTA Bruchlast 10.000 kg</p> 



## Zurrhaken

25 mm	25 mm	35 mm	35 mm
Spitzhaken 	S-Haken 	Spitzhaken 	Spitzhaken m. Sicherung 
Spitzhaken lang 	Flachhaken abgewinkelt 	Klauenhaken 	Wirbelhaken 
Klauenhaken 	Flachhaken 	Gedrehter Karabiner 	
Abschlepphaken 	Single Stud Fitting 	Triangelhaken 	
Triangelhaken 	Double Stud Fitting 	Spitzhaken eine Spitze 	
Flachhaken 	Double St. F. mit Ring 	Abschlepphaken 	
		Deltaring Rundmaterial 	

**Zurrhaken**

50 mm	50 mm		75 mm
Spitzhaken 	Schienenanker 	Deltaring flach 	Spitzhaken 
Klauenhaken 	Deltaring flach mS 	D-Bügel 	Klauenhaken 
Gedrehter Karabiner 	Rundhaken 	Triangel gleichschenkelig 	Triangelhaken 
Triangelhaken 	Flachhaken 	Triangel gleichseitig 	Bandbügel +SIKA Haken 
Spitzhaken eine Spitze 	Gerader Karabiner 	Krone Haken 	Bandbügel 
Spitzhaken m. Sicherung 	Gerader Karabiner kurz 	Bordwandkralle 	
FP Profilhaken 	Kögel Haken 	Sonderhaken FHAM 	

**SEWOTA Zurrgurt mit ERGO-Langhebelratsche**

Typ 5402, mit allen gängigen Hakentypen kombinierbar, GS

Niederzurren

**STF 400 daN**

Diagonalzurren

**LC 2500 daN****SEWOTA Zurrgurt mit ERGO-Langhebelratsche**

Typ 15502, mit allen gängigen Hakentypen kombinierbar, GS

Niederzurren

**STF 500 daN**

Diagonalzurren

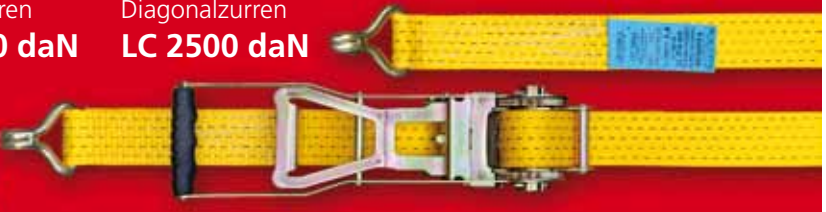
**LC 2500 daN****SEWOTA Zurrgurt mit ERGO-Langhebelratsche**

Typ 5702, mit allen gängigen Hakentypen kombinierbar, GS

Niederzurren

**STF 700 daN**

Diagonalzurren

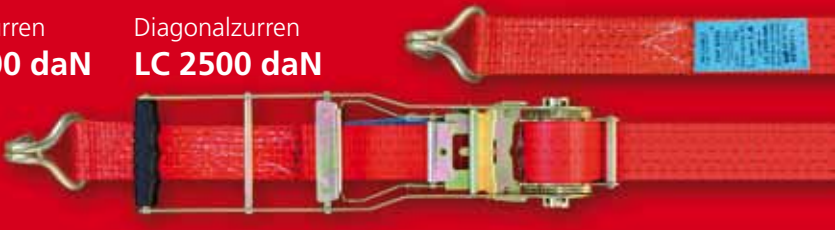
**LC 2500 daN****SEWOTA Zurrgurt mit ERGO-Langhebelratsche**

Typ 5502, mit allen gängigen Hakentypen kombinierbar, GS

Niederzurren

**STF 500 daN**

Diagonalzurren

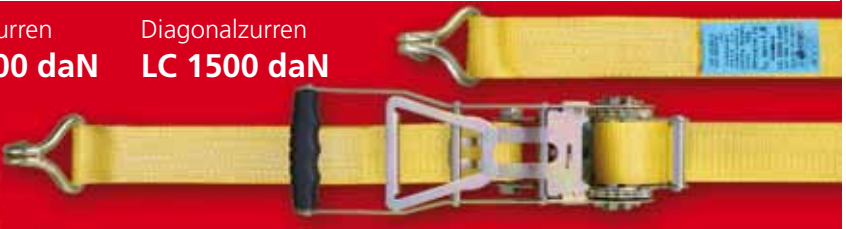
**LC 1500 daN**

# ZG

## Kurzinfo Etiketten an Zurrgurten

Zurrgurte können im Niederzurrverfahren (kraftschlüssig) oder im Direktzurrverfahren (schräg und diagonal - formschlüssig) eingesetzt werden. Hierzu finden Sie umfangreiche Informationen in unseren Bedienungsanleitungen - auch unter [www.sewota.de](http://www.sewota.de). Gerne erläutern wir Ihnen an dieser Stelle die wichtigsten Kennzahlen auf unseren Zurretiketten:

<b>EN 12195-2</b>	
Code   2223242 SE / 8391050 03/2015 <b>PES</b>	
<b>TYP 15502</b>	
<b>ZURRGURT</b> <b>ERGO LONG HANDLE</b> Lashing System	
<b>Dehnung max. 5%</b>	
<b>IGF Länge in m: 0,4</b>	
	<b>NIEDERZURREN</b> <b>LASHING DOWN</b> S <sub>HF</sub> 50 daN S <sub>TF</sub> 500 daN
	<b>DIAGONALZURREN</b> <b>DIAGONAL LASHING</b> LC 2500 daN
<b>NICHT HEBEN - NUR ZURREN!</b> <b>NO LIFTING - ONLY LASHING!</b>	
	<b>SEWOTA</b> GmbH Bachgasse 6 07922 TANNA
VL 13048	
Nächste Prüfung/next check:	
16	17
18	19
20	

derzeit gültige EN Norm für Zurrgurte

Interner Code und Seriennummer zur Nachvollziehbarkeit (Material, Produktion...)

Handelsbezeichnung des Zurrgurtes in verschiedenen Sprachen

Dehnungsverhalten des Gurtbandes

Länge des Fest- oder Losendes (immer nur Band+Haken - ohne Ratsche)

Zurrgurte werden am meisten im Niederzurrverfahren angewendet.  
STF in daN = zulässige Vorspannkraft des Zurrgurtes im Niederzurrverfahren bei einer maximalen Handhebelkraft (SHF) von 50 daN

LC = zulässige Zurrkraft in daN - gilt nur dann wenn der Zurrgurt im Direktem Zurrverfahren eingesetzt werden darf. Es ist nur ein LC Wert auf den Etiketten zulässig.

Warnhinweis - Zurrgurte dürfen niemals zum Heben von Lasten benutzt werden!

Herstellerhinweis und gültiges GS Zeichen

Prüfleiste für die mindestens jährlich durchzuführende Sachkundigenprüfung

**Zurrgurte 2-teilig, Ausführung mit Triangelhaken**



Artikel	Ratsche	Band in mm	LC daN	LC daN	STF daN	4 m á/St. in CHF	6 m á/St. in CHF	8 m á/St. in CHF	+/- m in CHF
<b>2216--/H</b>	Hobbyratsche	25	400	800	75	6,00	7,50	9,50	1,00
<b>3216--</b>	Druckratsche	35	1.000	2.000	150	17,00	19,00	21,00	2,00
<b>5216--</b>	Druckpower	50	2.500	5.000	300	30,00	31,00	34,00	3,00
<b>5216--/LH</b>	Langhebelratsche	50	2.500	5.000	400	39,00	43,00	48,00	3,00
<b>5416--</b>	ERGO 400	50	2.500	5.000	400	40,00	44,00	49,00	3,00
<b>5516--</b>	ERGO 500 S	50	1.500	3.000	500	42,00	46,00	51,00	3,00
<b>15516--</b>	ERGO 500	50	2.500	5.000	500	42,00	46,00	53,00	3,00
<b>5716--</b>	ERGO 700	50	2.500	5.000	700	46,00	48,00	230,00	3,00
<b>10216--</b>	Druckratsche	75	5.000	10000	500	190,00	210,00	230,00	10,00

Hobbyratsche



Druck- Powerratsche mit Softlösefunktion



Langhebelratsche ERGO 400,500oder 700



# ZK2 (2-teilig)

Nach EN 12195-3 zur Schwerlastverzurrung. Zweiteilige Zurreinheit bestehend aus Kettenbauteilen der Güteklasse 8 oder 10. Die Zurrkette besteht aus einer hochfesten Kette mit beidseitig anmontierten Gabelkopfhaken und einem separaten Ratschlastspanner incl. Verkürzungshaken mit PIN.

Heavy Duty Chain Lashing ZK1 type, special system with components grade 80 or grade 100, acc. EN 12195-3





Artikel	zulässige Zugkraft LC in daN	Länge length in m	Bauteile components	STF bei SHF 50 daN	Preis á/St. in CHF	Kette + á/m in CHF
<b>ZK 2 6 - 8</b>	2.200	3,5	6-8	1.900	160,00	12,00
<b>ZK 2 8 - 8</b>	4.000	3,5	8-8	2.000	180,00	18,00
<b>ZK 2 10 - 8</b>	6.300	3,5	10-8	3.150	230,00	24,00
<b>ZK 2 13 - 8</b>	10.000	3,5	13-8	3.150	330,00	34,00
<b>ZK 2 16 - 8</b>	16.000	3,5	16-8	3.150	530,00	54,00
<b>ZK 2 8 -10</b>	5.000	3,5	8-10 (XXL)	2.350	280,00	27,00
<b>ZK 2 10 -10</b>	8.000	3,5	10-10 (XXL)	2.650	375,00	36,00
<b>ZK 2 13 -10</b>	13.000	3,5	13-10 (XXL)	3.450	515,00	58,00
<b>ZK 2 8 -12</b>	6.000	3,5	8-12	1.900	490,00	50,00
<b>ZK 2 10 -12</b>	10.000	3,5	10-12	3.000	545,00	70,00
<b>ZK 2 13 -12</b>	16.000	3,5	13-12	2.500	770,00	105,00

## Ratschen Lastenspanner RLSP Haken mit Sicherung

	Nenngröße	l min	l max	daN zul. Zurrkraft	Preis á/St. CHF
	<b>6-8</b>	445	525	2.200,00	49,00
	<b>8-8</b>	600	750	4.000,00	58,00
	<b>10-8</b>	603	770	6.300,00	62,00
	<b>13-8</b>	710	850	10.000,00	65,00
	<b>16-8</b>	710	850	16.000,00	90,00
	<b>8-10</b>	355	500	5.000,00	138,00
	<b>10-10</b>	365	510	8.000,00	175,00
	<b>13-10</b>	576	866	13.400,00	225,00
	<b>8-12</b>	355	500	6.000,00	224,00
	<b>10-12</b>	365	510	10.000,00	262,00
	<b>13-12</b>	576	866	16.000,00	366,00

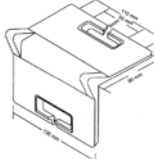

**Kantenschutzzecke**

	Gurtband max. mm	Material	Artikelnummer	Preis á/St.CHF
	<b>50</b>	PVC	KSE	3,00
	<b>50</b>	Stahl	KSE-S	6,00
	<b>75</b>	PVC	KSE-Jumbo	7,00

**PU Kantenschutzplatte**

	Gurtband in mm	Größe in mm	Aussparung in mm	Preis á/St.CHF
	<b>25</b>	250 x 80	25 x 10	8,50
	<b>35</b>	250 x 80	35 x 10	9,00
	<b>50</b>	300 x 100	55 x 10	12,00
	<b>60</b>	450 x 100	70 x 30	28,00
	<b>75</b>	450 x 120	80 x 30	32,00
	<b>90</b>	470 x 130	90 x 40	38,00
	<b>130</b>	470 x 170	130 x 40	41,00
	<b>150</b>	470 x 200	160 x 40	46,00
	<b>180</b>	470 x 240	200 x 40	49,00
	<b>240</b>	500 x 280	250 x 40	53,00
	<b>300</b>	600 x 400	320 x 40	70,00



## Zurmulde

	Bruchlast in daN	Artikelnummer	Preis á/St.CHF
	2000	8030-2	12,00

## PU Kantenschutzwinkel

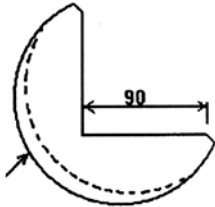
	Gurtband in mm	Anzahl Magnete	ohne Magnet Preis á/St.CHF	mit Magnet Preis á/St.CHF
	<b>KW 25</b>	2	70,00	102,00
	<b>KW 40</b>	2	75,00	108,00
	<b>KW 65</b>	2	80,00	112,00
	<b>KW 75</b>	4	92,00	149,00
	<b>KW 100</b>	4	105,00	170,00
	<b>KW 125</b>	4	114,00	179,00
	<b>KW 150</b>	4	123,00	188,00
	<b>KW 200</b>	6	158,00	275,00
	<b>KW 300</b>	8	198,00	325,00

## Antirutschmatten

	Breite	Länge	Dicke	Reibwert my	Preis á/Rolle CHF
	0,25 m	5,0 m	8 mm	0,8	35,00
					

Andere Abmessungen sowie Anti- Rutschmattenpads bieten wir Ihnen gerne an.

Artikel	Maschenweite in mm	Stärke in mm	Grösse in m	Preis per Stk. CHF	Zusatzpreis Gummileine
20301-045-01	45	3	3.0 x 5.0	80.00	+30.00
20281-045-01	45	3	3.0 x 6.0	90.00	+35.00
20311-045-01	45	3	3.0 x 7.0	110.00	+40.00
20291-045-01	45	3	3.0 x 8.0	120.00	+45.00
2028-045-01	45	3	3.5 x 6.0	110.00	+40.00
2031-045-01	45	3	3.5 x 7.0	125.00	+45.00
2029-045-01	45	3	3.5 x 8.0	140.00	+50.00
2366-045-01	45	3	2.7 x 2.5	50.00	+10.00
2486-045-01	45	3	2.7 x 3.5	75.00	+15.00
2469-045-01	45	3	2.7 x 4.1	80.00	+20.00

Sondergrössen auf Anfrage.

## Container & Pritschenplanen (Luftdurchlässig)

Artikel	Material	Gewicht g/m <sup>2</sup>	Grösse in m	Preis per Stk. CHF	Zusatzpreis Gummileine
7201-015	PE	200	3.5 x 5.0	110.00	+35.00
7206-015	PE	200	3.5 x 6.0	135.00	+40.00
7208-015	PE	200	3.5 x 8.0	180.00	+50.00
7213-015	PE	200	2.0 x 3.0	82.00	Inkl.
7266-015	PE	200	2.7 x 2.5	80.00	Inkl.
7268-015	PE	200	2.7 x 3.5	125.00	Inkl.
7269-015	PE	200	2.7 x 4.1	135.00	Inkl.

Sondergrössen auf Anfrage.



**Containerplanen (Raschelgewirke)**

schwere Ausführung (10 % Luftdurchlässigkeit)

Artikel	Material	Stärke (Gewicht)	Farbe	Größe in m	Gummispannleine ringsum	Preis á/St. CHF
77531-04	PE-Gewirke	320	blau	2,9 x 5,0	nein	208,00
77536-04	PE-Gewirke	320	blau	2,9 x 6,0	nein	250,00
77532-04	PE-Gewirke	320	blau	2,9 x 7,0	nein	290,00
77538-04	PE-Gewirke	320	blau	2,9 x 8,0	nein	332,00

**Containerplanen (Raschelgewirke)**

schwere Ausführung (50 % Luftdurchlässigkeit)

Artikel	Material	Stärke (Gewicht)	Farbe	Größe in m	Gummispannleine ringsum	Preis á/St. CHF
7851-01	PP hochfest	550	grün	3,15 x 5,0	nein	216,00
7852-01	PP hochfest	550	grün	3,15 x 7,0	nein	302,00

**Kettenratschzug Kito**

	Tragfähigkeit WLL in kg	Kettenstränge	1,5 m Hub á/St. CHF	Mehrhub je Meter CHF
	500	1		
	1000	1		
	1500	1		
	2000	2		

Preise auf Anfrage!

**Kettenratschzug Kito LB**



	Tragfähigkeit WLL in kg	Kettenstränge	1,5 m Hub á/St. CHF	Mehrhub je Meter CHF
	800	1	-	-
	1.000	1	-	-
	1.600	1	-	-
	2.500	1	-	-
	3.200	1	-	-
	6.300	2	-	-
	9.000	3	-	-



Preise auf Anfrage!

**Trägerklemme HADEF - 221/05**

	Artikel	Tragfähigkeit WLL in kg	Träger- flanscbreite in mm	Eigenge- wicht in kg	Preis à/St. CHF
	<b>220-1000</b>	1.000	75 - 230	4	230,00
	<b>220-2000</b>	2.000	75 - 230	5	282,00
	<b>220-3000</b>	3.000	80 - 320	10	398,00
	<b>220-5000</b>	5.000	80 - 320	12	605,00
	<b>220-10000</b>	10.0000	90 - 320	16	1015,00

**Kettenratschzug YALE HANDY**

	Tragfähigkeit WLL in kg	Kettenstränge	1,5 m Hub à/St. CHF	Mehrhub je Meter CHF
	<b>250</b>	1	235,00	26,00
	<b>500</b>	1	316,00	26,00
	<b>250-KITO LX</b>	1	-	-
	<b>500-KITO LX</b>	1	-	-

**Stirnradflaschenzug HADEF - 8/12**

	Tragfähigkeit WLL in kg	Ketten- stränge	Hakenmaß min. in mm	3 m Hub á/St. CHF	Mehrhub je m CHF
	<b>250</b>	1	250	360,00	52,00
	<b>500</b>	1	275	375,00	62,00
	<b>1.000</b>	1	342	445,00	70,00
	<b>1.500</b>	1	378	558,00	94,00
	<b>2.000</b>	2	403	640,00	94,00
	<b>3.000</b>	2	510	838,00	160,00
	<b>5.000</b>	2	615	1114,00	182,00
	<b>10.000</b>	4	760	2992,00	335,00

**Stirnradflaschenzug C21**

	Tragfähigkeit WLL in kg	Ketten- stränge	Hakenmaß min. in mm	3 m Hub á/St. CHF	Mehrhub je m CHF
	<b>500</b>	1	275	294,00	40,00
	<b>1.000</b>	1	310	323,00	42,00
	<b>1.500</b>	1	340	404,00	44,00
	<b>2.000</b>	1	380	502,00	50,00
	<b>3.000</b>	2	480	649,00	75,00
	<b>5.000</b>	3	555	1018,00	120,00

**Blechgreifer für Härten unter HRC30**

	Artikel	Tragfähigkeit WLL	Greifbereich in mm	Preis á/St. CHF
	<b>CS - 0.75</b>	750	0 - 13	345,00
	<b>CS - 1.0</b>	1.000	0 - 20	395,00
	<b>CS - 1.5</b>	1.500	0 - 20	398,00
	<b>CS - 2.0</b>	2.000	0 - 35	430,00
	<b>CS - 3.0</b>	3.000	0 - 35	458,00
	<b>CS - 4.0</b>	4.000	0 - 45	560,00
	<b>CS - 6.0</b>	6.000	0 - 50	880,00
	<b>CS - 9.0</b>	9.000	0 - 60	1240,00
	<b>CS - 12.0</b>	12.000	0 - 75	1310,00
	<b>CS - 15.0</b>	15.000	0 - 75	2460,00
	<b>CU - 0.75</b>	750	0 - 13	412,00
	<b>CU - 1.0</b>	1.000	0 - 20	525,00
	<b>CU - 1.5</b>	1.500	0 - 20	540,00
	<b>CU - 2.0</b>	2.000	0 - 35	626,00
	<b>CU - 3.0</b>	3.000	0 - 35	710,00
	<b>CU - 4.0</b>	4.000	0 - 45	895,00
<b>CU - 6.0</b>	6.000	0 - 50	1291,00	
<b>CU - 9.0</b>	9.000	0 - 60	1712,00	
	<b>SKTBL 0.5</b>	500	0 - 16	355,00
	<b>SKTBL 1.0</b>	1.000	0 - 20	405,00
	<b>SKTBL 2.0</b>	2.000	0 - 32	498,00
	<b>SKTBL 3.0</b>	3.000	0 - 32	624,00
	<b>TBL 4.0L</b>	4.000	30 - 60	840,00
	<b>TBL 6.0L</b>	6.000	50 -100	1097,00
	<b>TBL 8.0L</b>	8.000	50 -100	1468,00
	<b>TBL 10.0L</b>	10.000	50 -100	1665,00
	<b>TBL 12.0L</b>	12.000	50 -100	2890,00
	<b>TBL 15.0L</b>	15.000	50 -100	3450,00
	<b>TBL 20.0L</b>	20.000	65 -130	5302,00
	<b>TBL 30.0L</b>	30.000	65 -130	7200,00

## Trägergreifer - Sicherheitsarretierung

	Artikel	Tragfähigkeit WLL	Greifbereich in mm	Preis á/St. CHF
	<b>CBV - 1.0</b>	1.000	0-15	580,00
	<b>CBV - 2.0</b>	2.000	0-20	715,00
	<b>CBV - 3.0</b>	3.000	0-25	862,00
	<b>TTG 0.5</b>	500	0-20	684,00
	<b>TTG 1.5</b>	1.500	0-30	755,00
	<b>TTG 3.0</b>	3.000	0-35	940,00
	<b>TTG 4.5</b>	4.500	0-40	1444,00
	<b>TTG 7.5</b>	7.500	0-45	1912,00

## Schongreifer

	Artikel	Tragfähigkeit WLL	Greifbereich in mm	Preis á/St. CHF
	<b>TBP 0.5</b>	500	0-10	885,00
	<b>TBP 1.5</b>	1.500	0-20	1554,00
	<b>TSB 0.35</b>	350	0-65	1686,00
	<b>TSB 0.75</b>	750	0-65	1892,00
	<b>TSB 1.25</b>	1.250	0-65	2080,00



**Blechverladehaken**

	Artikel	Tragfähigkeit pro Stck. in kg	Preis à/St. CHF
	<b>BVH 0.5</b>	500	228,00
	<b>BVH 1.1</b>	1.120	328,00
	<b>BVH 1.5</b>	1.500	378,00
	<b>BVH 2.0</b>	2.000	400,00
	<b>BVH 2.5</b>	2.500	630,00
	<b>BVH 3.2</b>	3.200	685,00
	<b>BVH 4.0</b>	4.000	860,00
	<b>BVH 5.0</b>	5.000	1010,00
	<b>BVH 6.0</b>	6.000	1360,00
	<b>BVH 7.5</b>	7.500	1920,00

Gerne bieten wir Ihnen diverse Lastaufnahmemittel an:

		
<b>TCH</b>	<b>TGF</b>	<b>THS und TTT</b>
		
<b>TWH</b>	<b>THK</b>	<b>THG</b>

## Kranwaage Typ DSD 04

	Typ type	Meßbereich measuring range	Gewicht kg weight	Preis á/St. CHF
	<b>DSD 04 - 2.5</b>	0 - 2.500 kg	1,3	1590,00
	<b>DSD 04 - 5.0</b>	0 - 5.000 kg	1,9	1620,00
	<b>DSD 04 - 10.0</b>	0 -10.000 kg	3,6	1790,00
	<b>DSD 04 - 20.0</b>	0 -20.000 kg	7,0	2750,00

**Genauigkeit:** +/- 0,15%, Schutzart IP 65,  
**Lieferumfang:** Kunststoffkoffer, Batteriebetrieb 9 V,  
 jedoch ohne Schäkel und Haken

## Kranwaage Typ DSD 01

	Typ type	Meßbereich measuring range	Gewicht kg weight	Preis á/St. CHF
 <p>Dynamometer 01T</p>	<b>DSD 01 - 0.6</b>	0 - 600 kg	2,3	1320,00
	<b>DSD 01 - 1.0</b>	0 - 1.000 kg	2,3	1397,00
	<b>DSD 01 T - 3.2</b>	0 - 3.200 kg	4,2	1542,00
	<b>DSD 01 T - 6.3</b>	0 - 6.300 kg	6,5	1740,00
	<b>DSD 01 T - 10.0</b>	0 -10.000 kg	9,6	2420,00
	<b>DSD 01 TX/RX- 3.2</b>	0 - 3.200 kg	4,2	2905,00
	<b>DSD 01 TX/RX- 6.3</b>	0 - 6.300 kg	6,5	3025,00
	<b>DSD 01 TX/RX-10.0</b>	0 -10.000 kg	9,6	3574,00

**Typ DSD 01:** Standard Kranwaage  
**Typ DSD 01 T:** Standard Kranwaag mit Fernbedienung  
**Typ DSD 01 TX/RX:** Kranwaage mit Fernbedienung und Fernableseeinheit  
**Genauigkeit:** +/- 0,15%, Schutzart IP 65

**Rohr- Schachtringgehänge / Concrete pipe lifting gear**

Rohrgehänge 1061 aus verwindungsfreier Stahlhohlbauweise.  
Einstellbarer Spannungsbereich durch Spannschraube, hochfeste Ketten.

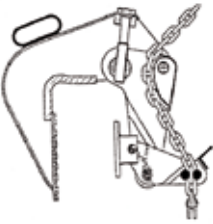
	Artikel	Tragfkt. WLL in kg	Spannbereich in mm	Griff-tiefe in mm	Rohre max. in m	Ketten-länge in m	Preis á/St. in CHF
	<b>1061.1</b>	1.500	0-130	200	2	1,6	720,00
	<b>1061.2</b>	1.500	0-130	200	3	2,2	825,00
	<b>1061.3 G</b>	1.500	0-75	200	2	1,7	1215,00
	<b>1061.4</b>	3.000	0-180	220	2	1,7	1110,00
	<b>1061.5</b>	3.000	0-180	220	3	2,3	1258,00
	<b>1061.6 G</b>	3.000	0-135	220	2	1,8	1830,00
	<b>1061.7</b>	4000	50-180	220	3	2,5	2550,00
	<b>1061.10</b>	3.000	90-200	260	2	1,7	1480,00
	<b>1061.11</b>	3.000	90-200	260	3	2,3	1610,00
	<b>1061.12</b>	3.000	90-230	240	2	1,7	1544,00
	<b>1061.13</b>	3.000	90-230	240	3	2,3	1686,00
	<b>1061.14</b>	3.000	0-250	260	2	1,8	1790,00
	<b>1061.15</b>	3.000	0-250	260	3	2,5	1914,00



**Permanent-Magnet SH / MK**

Hand- u. Kranbetrieb

	Artikel	Hebekraft in kg	Haftfläche in mm	Blech- stärke in mm	Preis á/St. CHF
	<b>SH 15</b>	150	150 x 150	2	222,00
	<b>MK 120</b>	120	140 x 84	1	322,00
	<b>MK 170</b>	170	140 x 116	2	375,00
	<b>MK 300</b>	300	160 x 180	2	515,00

**Permanent-Magnet PML**

Kranbetrieb

	Artikel	Hebekraft in kg	Haftfläche in mm	Eigen- gewicht in kg	Preis á/St. CHF
	<b>PML - 1</b>	100	88 x 62	2,6	390,00
	<b>PML - 3</b>	300	158 x 92	9	760,00
	<b>PML - 6</b>	600	228 x 176	22	1180,00
	<b>PML -10</b>	1.000	258 x 176	48	2040,00
	<b>PML -20</b>	2.000	378 x 234	110	3940,00
	<b>PML -30</b>	3.000	450 x 280	210	5580,00

Permanentmagnete PML sind auch für Rundmaterialien geeignet. Hierbei verringern sich jedoch die Hebekräfte um ca. 50 % in Abhängigkeit der Materialdurchmesser. Gerne beraten wir Sie hierzu.

Hubtische, angefertigt in der Schweiz von Bircher Montech GmbH  
Massiver Scheren- Hubtisch fahrbar.

**Technische Daten:**

Hubhöhe:	von 480 -1450 mm
Gewicht:	220 kg
Behandlung:	Pulverbeschichtet
Plattformgrössen:	Länge 1800 bis 2100 mm Breite 800-1100 mm
Plattform:	Chromstahlblech 4 mm abgekantet
Fahrwerk:	Zwei Bock und Zwei Lenkrollen
Betriebsart:	Fusspumpe oder Elektropumpe
Sonderlösung:	Auch in Edelstahl erhältlich

Durch seine Kreuz- Rohrkonstruktion ist der Hubtisch sehr Stabil.  
Sämtliche Rollen und Bolzen sind Kugel oder Messing Gelagert.

Gerne fertigen wir Ihnen einen Hubtisch nach Ihren bedürfnissen an!

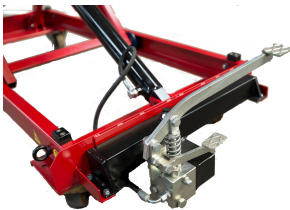

Preis auf Anfrage!



<b>Rabattstufen pro Einkauf:</b>	0 - 150.00 CHF	<b>0%</b>
	150.00 – 400.00 CHF	<b>10 %</b>
	400.00 – 650.00 CHF	<b>12 %</b>
	650.00 -	<b>Auf Anfrage!</b>

**Kontaktdaten:****Bircher Montech GmbH**

Stechenrain

6016 Hellbühl

Tel: 079 728 87 33 / 079 852 34 46

Mail: martin.bircher@bircher-montech.ch

www.bircher-montech.ch

## Ladungssicherung Komplettsset

- 4x Zurrgurte 8.0 m 2500/5000 daN mit Power- Tatische 2- Teilig.
- 4x Zurrgurte 6.0 m 1000/2000 daN 2- Teilig.
- 6x Zurrgurte 4.0 m 800 daN 1 Teilig

**NUR 199.00**





4 Stk. 2.00 to.



4 Stk. 3.20 to.



4 Stk. 4.75 to.

### Schäkel- Set 12- Teilig

2.0 t 4 Stk.

3.2 t 4 Stk.

4.75 t 4 Stk.

**Nur 85.—**

\*Für dieses Angebot gelten keine Rabattstufen